

PHASE**ONE**

what the world's best photography is made of

XF Camera System User Manual



Content | XF Camera System Manual

Dials, Buttons and Touch Screen Interface	4		
Lens, XF Camera Body	4	Flash Analysis Tool	33
IQ Digital Back	5	Vibration Analysis Tool	33
		Capture Analysis Popup	33
Primary parts of the XF Camera System	6	IQ Digital Back Navigation	34
Lens, XF Camera Body, IQ Digital Back	6	IQ Digital Back Overview	34
		Touch Screen Operation	34
Assembling the XF Camera System	8	IQ Digital Back Contextual Menu	36
Digital Back and Camera Body Modularity	8	Features available from the Home Screen	37
Interchangeable Viewfinders	9		
Readying the camera system	10	Tools and settings in View Mode	38
Charging the batteries	10	Histogram	39
Loading og removing the batteries	12	Exposure and Clip Warning	39
		Focus Mask	39
Navigating the XF Camera System	14	Alignment	39
Top Touch Screen	14	File Info	40
Three dials and two keys	14	Exposure Calculator	40
Camera menu	14	Sensor Temperature	40
User configurable buttons	14	Exposure Zone	41
XF Camera Body Controls	15	Camera Controls	41
Customizing buttons and dials	18	Prism Viewfinder Display and Functions	42
Changing the function of a dial or button	18	Viewfinder Overview	42
		Autofocus Area	42
OneTouch User Interface Flow Diagram	20	Viewfinder Display	42
XF Camera Menu Overview	20		
IQ Digital Back Menu Overview	22	XF Camera System Settings Overview	44
		Shutter Speed	44
OneTouch User Interface Overview	25	Aperture	44
XF Camera Body Navigation	25	ISO Selection	44
Dials	25	AF/MF	45
Top Touch Screen Operation	25	AF Drive Mode	45
User Control Buttons	25	AF Area Mode	45
Customize the Icon Controls	27	Capture Mode	45
		Exposure Mode	45
XF Tools on the Top Touch Screen	28	Metering Mode	45
HDR Tool	28		
Timelapse Tool	29	IQ Digital Back Basic Settings	46
Focus Stack Tool	29	ISO	46
Hyperfocal Tool	30	White Balance	46
Focus Trim Tool	31	File Formats	47
Profoto Remote Tool	32		
Seismograph Monitor	32	Custom White Balance	48
BullsEye Level Tool	32	Creating a Custom White Balance	48

Content | XF Camera System Manual

Saving Custom White Balance Settings	48	XF Camera System Lenses	79
Honeybee Autofocusing System	49	Focal Plane and Leaf Shutter Lenses	79
AF Drive mode setting	49	Capture One Pro	80
AF Priority setting	50	Activating Capture One Pro (Mac / Windows)	82
AF Area Modes	50	Capture One Tethered Use	83
Focus Trim Tool	53	Shooting Tethered	83
Preparation and setup	53	Built-In WiFi and Capture Pilot	85
Autofocus & Recompose mode / AFR Mode	56	WiFi Setup	85
Using AFR mode to recompose	56	A-series Camera System	88
Working with hyperfocal distance	58	Factory Lens Calibrations (FLC)	88
Hyperfocal distance on the XF Camera System	59	IQ Digital Backs and Cambo Technical Cameras	90
XF Camera System Capture Modes	60	Shooting with the Electronic Shutter (ES)	92
Capture Modes	60	Shooting with a two-shot release procedure	94
XF Camera System Exposure Modes	62	Zero Latency Shutter Release	96
Changing the Exposure Mode	62	Using Lens Cast Calibration	98
Auto ISO Setting	62	IQ Digital Backs with third party cameras	99
OneShot AE Exposure Mode	62	IQ Digital back Camera Mode setting	100
Exposure Compensation	64	IQ Digital Backs and Technical Cameras	104
Using Exposure Compensation	64	IQ Digital Back Latency and Mechanical Shutters	104
Long Exposure	65	System Maintenance	105
Noise Reduction (Dark Frame Subtraction)	65	Keeping your XF Camera clean	105
Electronic Shutter (ES)	66	Cleaning the Sensor on IQ Digital Back	107
Enabling the Electronic Shutter	66	Updating the XF Camera Firmware	109
Live View	68	Learning More	115
Live View on the IQ Digital Back	68	Phase One Customer Service	115
XF Custom Presets and System Backup	71	Phase One Technical Support	115
XF Camera Body Custom Presets	71	Phase One Information	116
Flash Photography	74	Warranty and Uptime Guarantee	116
Profoto Remote Tool	75	General Conditions	116
Enabling Profoto Air Sync and Air Remote	75	General Conditions	118
Triggering a Capture with the Profoto Remote	76	Notices	119
Flash Analysis Tool	77		
Rear Curtain sync and Trim	77		

[Jump to
specific Section](#)

Dials, Buttons and Touch Screen Interface

Lens, XF Camera Body, IQ Digital Back

XF Camera Body

Shutter release buttons and user buttons are all positioned within reach of your fingers. These are all used for photography applications and are referred to as “buttons” as opposed to “keys” which are the user interface keys designed to control the user interface on the OneTouch UI described later in this manual.



XF Camera Body

The top screen of the XF Camera Body has a touch-sensitive transfective LED display, providing a mix of direct access to features as well as a menu system navigated using the dials and keys. All the controls are customizable.



IQ Digital Back



Primary parts of the XF Camera System

Lens, XF Camera Body, IQ Digital Back





Assembling the XF Camera System



Digital Back and Camera Body Modularity

Depending on how you purchased the system, the XF Camera System may be supplied ready for use with the IQ Digital Back already attached, and consequently, there is no need to remove it prior to capture. If, however, you would like to do so, for example, to use it with a technical camera, please follow the instructions below.

Removing the IQ Digital Back from the XF Camera Body

1. Turn the Camera System off and remove any interface cables from the Digital Back.
2. Push the IQ Digital Back lock slider toward the XF Camera Body while simultaneously pressing the IQ Digital Back release button. Note that the lock slider acts as a safety catch.
3. Tilt the IQ Digital Back slightly backward from the top and gently lift the IQ Digital Back off the XF Camera's guide rail.

NOTE:

After removing the IQ Digital Back from the XF Camera Body, remember to protect the sensor by reattaching cover, and to attach the back port cover on the XF to protect the camera from dust.

Attaching the IQ Digital Back to the XF Camera Body

1. Gently place the mounting plate of the IQ Digital Back onto the bottom guide rail of the XF Camera Body.
2. Push the back lock slider and press the release button simultaneously to retract the back's upper locking mechanism, and then push the IQ Digital Back firmly onto the camera's twin catches, using the bottom guide rail as a pivot.

Removing the lens

1. Press the lens release button on the right-hand side front of the camera and keep pressed.
2. Rotate the lens counter-clockwise on the body until it stops, and lift it out carefully from the body.

Attaching a lens

1. Looking down from the top of the camera, or from right hand side, align the blue or the red index point on the lens with the blue or red index points located on bayonet mount of the XF Camera Body and rotate clockwise on the body until it stops and clicks into position.

Two different colored index points are available to allow easier attachment of the lens to the camera. Either when looking downwards from above the camera (blue), or in front of the camera looking from the side (red).

If you are not replacing with another lens, then reattach the front and rear caps, and keep them always attached to the body to protect the mirror-mechanism or lens elements from accidental damage.



Interchangeable Viewfinders

In addition to the Prism Viewfinder, the XF features an optional Waist Level Finder (Part # 73090).

Removing the Viewfinder

1. Ensure the power of the XF Camera System is Off.
2. Grasp the viewfinder securely with your right-hand and push the viewfinder release slider forwards, towards the lens with the right thumb.
3. Lift the viewfinder up and out carefully, beginning with the rear of the viewfinder then moving up and away from the camera body.

Attaching the Viewfinder

1. Ensure the power of the XF Camera System is Off.
2. Hold the viewfinder securely with your right hand, with the viewfinder tilting downwards slightly.
3. Place the front edge of the viewfinder so that it is resting on the front edge of the body.
4. Ensure that the viewfinder's front locating pins are aligned with the body's pin registration recesses, located in the front of the XF Viewfinder port. (Both the electrical contacts and prism of the viewfinder must be aligned with the body's contacts and viewfinder screen recess.)
5. Carefully lower the rear of the viewfinder until level with the body, then press the viewfinder down firmly until it clicks into place.

NOTE:

Ensure the viewfinder is securely attached before turning the power on and using the camera. Failure to ensure the viewfinder and body are properly secured could result in a camera malfunction. There is also a risk of dropping either the camera or the viewfinder if the viewfinder is not securely attached! Always remember to protect the optical elements.

XF Waist Level Finder Diopters

You can replace the default magnifier lens of the XF Waist Level Finder with an optional Diopter and use the finder without eyeglasses in case you are nearsighted or farsighted. Each Waist Level Finder Diopter has a fixed correction value, for example minus two (-2), whereas the default magnifier is neutral (zero correction).

The Diopters are accessories and can be ordered by using these part numbers:

- 73094 XF Waist Level Finder Diopter +2
- 73095 XF Waist Level Finder Diopter +1
- 73096 XF Waist Level Finder Diopter 0 (Included with the WLF)
- 73097 XF Waist Level Finder Diopter -1
- 73099 XF Waist Level Finder Diopter -2

Readying the camera system



Charging the batteries

When working untethered, the standard power source of both the XF Camera Body and IQ Digital Back back is the 7.2 V (3400 mAh) BP-911/914/915 type rechargeable Li-ion battery.

To maximize battery performance, charge both batteries before use with the supplied Twin V Pro charger. Approximately 2.5 to 3 hours are required to fully charge exhausted batteries.

1. Slide open the charger base cover and fold back to form a stand.
2. Slide the batteries into the charger slots from the top down. If charging only one battery, either slot can be used.
3. The charge indicator will blink and display the battery's approximate capacity as a percentage.
4. When the first battery is recharged the charger will automatically start charging the second battery.
5. Charging is complete when the charge indicator stops blinking and the capacity level displays "100%".
6. Remove the batteries and unplug the cable from the charger.

Twin battery system

The XF Camera Body and the IQ Digital Back use identical 7.2 V (3400 mAh) BP-911, 914, 915 type rechargeable Li-on batteries and share the same charger for convenience, however the IQ Digital Back requires a battery to be loaded prior to use, also when working tethered to a computer using a bus-powered interface cable (FireWire 800 or USB 3.0).

XF and IQ power sharing

The XF Camera Body and IQ Digital Back are designed to share power from the two BP-915 type batteries in the system, thereby providing improved operation time for the full system. IQ1 and IQ2 backs cannot share power with the XF Camera, and therefore operate on their own battery, independent of the camera body.

IQ Digital Backs continue to feature their own power source, so that they may also be used with third-party camera systems.

General advice for the battery and charger

Charge the batteries before use

Batteries discharge when not in use. For optimum performance, charge the batteries before the camera and IQ Digital Back are expected to be used.

NOTE:

In low temperatures, keep spare batteries close to body temperature by storing in an inside jacket pocket. Li-Ion type batteries tend to lose efficiency under cold conditions.

Charge the batteries indoors

Only charge the batteries indoors (and away from moisture) at ambient temperatures between 5-35 Celsius(41-95 Fahrenheit).

Continued charging

Never store the battery connected to the charger for an extensive period of time. When charging is complete, remove the battery and unplug the charger from power outlet.

Only use approved batteries

Use only 7.2 V BP-915 type batteries only. Capacity in excess of 3300 mAh is recommended. Some third party batteries may not fit into the XF Camera Body or IQ Digital Back's battery compartment, due to differences in the manufacturing tolerances. Do not try to force a battery into the compartment. When pressing the battery release button it should slide out without being hindered. If a battery can't be removed, levering the battery out may cause damage. Please contact your Phase One dealer for advice.

Remove batteries when not in use

When the battery is left in the camera or the back a small amount of current is drawn, resulting in accelerated discharge and shorter battery life. Remove the batteries and replace the covers before storing. Dirt and fingerprints on battery terminals may cause loose connection and corrosion. Clean the contacts with a soft-cloth before loading the batteries.

Shooting tethered

Always keep a battery in the IQ Digital Back even when shooting tethered to a computer via a FireWire or USB connection.

Use in foreign countries

The AC power adapter is supplied with several power plug adaptors for international use. The power adaptor is compatible with 110 to 250 V AC (50/60 Hz) power sources.

Only use the original power adapter or 12 V DC car adapter (supplied)

It is not recommended to use a portable voltage transformer with the battery charger. Battery charging from a car's 12 V electrical socket is possible but the car battery will discharge if the engine is not running.

Powering On and Off from the XF Camera Body

Powering up both the XF and the IQ simultaneously is achieved with a short press of the On/Off button located on top rear of the grip on the the XF Camera Body. A long press of the same button will power off the XF. The IQ Digital Back will follow and power-off automatically after a few seconds. The XF and IQ may also powered on and off from the IQ Digital Back, using the back's power button.

Tip: As diagnostics are performed by the back first, powering up and shutting down is quicker using the IQ's power button.



Loading og removing the batteries

Loading the battery in the XF Camera Body

1. Open the battery compartment cover located in the base of the XF Camera Body grip.
2. Insert the battery with power contacts first.
3. Push the battery up until it locks into position.
4. Close the battery compartment cover.

Removing the battery from the XF Camera Body

1. Open the battery compartment cover.
2. Push the metal retaining catch inside the grip to release the battery and pull out.
3. Close the battery compartment cover.

Loading the battery in the IQ Digital Back

1. Open the battery cover located on the underside of the IQ Digital Back.
2. Insert the battery, power contacts first.
3. Push the battery up until it locks into position.
4. Close the compartment cover.

Removing a battery from the IQ Digital Back

1. Open the battery compartment cover.
2. Push the retaining catch inside the compartment to release the battery and pull out.
3. Close the battery compartment cover.

Battery life

The actual number of shots possible will vary depending on the shooting conditions. For instance Image Browsing, Autofocus operation, Live View, WiFi and Profoto Air use will reduce the number of shots available on a single charge. The age and condition of the battery also has an effect on battery life.

Setting Date, Time and Language

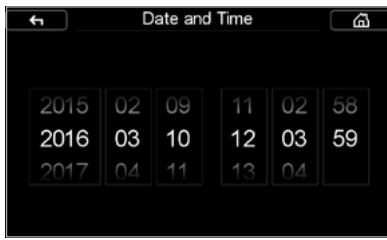

Setting the Date and Time on the IQ Digital Back



Setting the Date and Time on the IQ Digital Back

Date and time are set and controlled via the IQ Digital Back's menu. When the IQ Digital Back is initially shipped from factory, or if the IQ Digital Back has been without power for a long period of time, it will automatically prompt you to set the time and date.

Touch the screen and scroll through the numbers to attain the appropriate date and time. Tap the "Home" icon in the top right corner of the screen to exit the dialog and go to the Home Screen of the IQ Digital Back. The time and date is applied to the EXIF data in all files captured with the IQ Digital Back.

Setting Language on the IQ Digital Back

The XF Camera System is delivered, by default, with the language set to English. Follow the steps below to change the language of the IQ Digital Back to one of nine others available, including German, French, Swedish, Italian, Spanish, Chinese (simplified), Japanese, Korean and Russian.

1. From the Home Screen on the IQ Digital Back, press Menu.
2. Navigate to Language by touching the screen and scrolling down.
3. Select the preferred language option. A green check mark icon indicates the selected language.
4. Press the Upper Left Key on the IQ Digital Back to exit the menu.

NOTE:

If you choose a language by mistake, and can no longer read the menu, look for the menu item ending with (L). This is the Language menu option. Each choice is displayed using the native language, with English as the first option.

Using memory cards

The Phase One XF Camera System supports Type 1 CompactFlash (CF) cards only. Phase One recommends UDMA 7 type cards (800x speed or better) for optimal performance, however slower cards can be used. Microdrives and CF Type II cards are not recommended for use with IQ Digital Backs.



Installing and removing the CF card

Installing and removing the CF card

Insert the CF card into the media storage slot on the left-hand side of the IQ Digital Back with the card's front label facing the display-screen of the IQ Digital Back. If resistance is felt, stop immediately and check the card is oriented correctly.

Remove the card by pressing the black release lever just above the card - this first press will make the lever protrude and you can now press it a second time to eject the card. Make sure the eject lever is correctly closed before loading another card.

LED Lights

IQ Digital Backs feature two main LEDs located below the bottom left corner of the screen.

When capturing an image the **Green** LED will blink rapidly to indicate that the IQ Digital Back is busy. When the IQ screen is dimmed this Green light will continuously display to indicate that the camera is still ready to shoot.

A **Red** LED indicates that the IQ Digital Back is writing to the storage media, and therefore the buffer has not been emptied. On some older IQ1 Digital Backs there is an additional Red LED indicator located next to the CF card slot (beneath the cover). It is assigned to indicate CF card activity only.



LED Lights

Navigating the XF Camera System

Introduction to the Top Touch Screen, Dials, Keys and XF Camera Menu

Top Touch Screen

Central to the operation of the Phase One XF Camera System is the XF Camera Top Touch Screen. Sitting at the top of the large, ergonomic hand-grip this touch-sensitive, multi-functional screen displays the camera's essential settings, keeping you fully informed at all times. Access to all of that information is quite literally at your fingertips.

Not only does the Top Touch Screen allow you to make selections on the fly but also falling naturally under the fingers and thumb of your right hand are all the controls required to take command of the camera. To change the Exposure mode, AF mode or Metering mode, or switch between manual ISO and Auto, just touch what you want to adjust on the screen and select from the choices displayed.

Three dials and two keys

The XF Camera Body is designed with a dedicated, ergonomically placed dial for each of the exposure settings; Shutter Speed, Aperture value and ISO. The dials are highly customizable allowing, for instance, any one of them to be reconfigured to alter exposure compensation in Av/Tv or Program, this gives you direct control of the exposure mode.

The dials are modal, switching their function to navigate the Top Touch Screen's integral menu system, or to scroll through each of the displayed function settings as a shortcut, depending on which mode is selected. A single press of one of the two aluminum Top Keys is all that's required.

The Front Key accesses the touch screen's shortcut Camera Function mode, while the Rear Key is used to reveal the integral Camera Menu.

Camera menu

In the menu system, the Front Dial is always used to scroll up and down through the options, while either the Rear or Side Dial is used to navigate to the next level and ultimately to select settings. That can't be changed to avoid confusion, but we've made the Top Front and Rear Keys modal and they're customizable as well. You can move up and down the menu with either set of controls or reconfigure the keys to move between levels, but you'll still need to make selections using the Rear or Side Dial.

User configurable buttons

None of the buttons are labelled, as the features they access are customizable. The Secondary Shutter Release Button, for example, located at the front of the camera, and two the User Buttons, are easily reconfigured from the Top Touch Screen's Camera Control menu.

Once a function has been chosen, a simple half press of the shutter button is all that is required to return the camera to full readiness, so you'll never miss a shot. The only time you will be asked to confirm the settings is when storing or loading groups of settings in one of the three Custom modes, or when restoring the camera to the default (factory) settings. No further confirmation of the settings is necessary, meaning that you can rest assured, the settings are always stored when leaving the menu system.

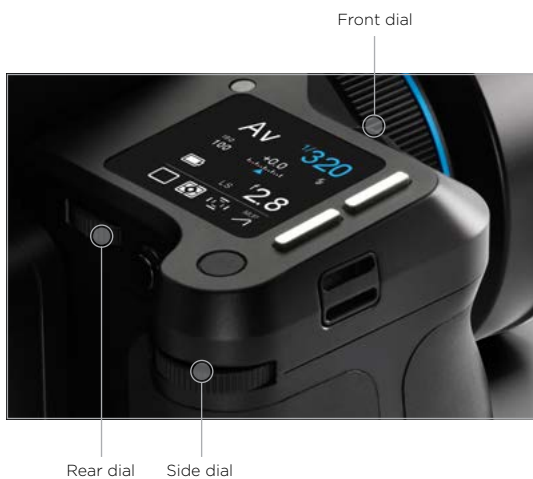

XF Camera Body Controls

NOTE:

If AF priority is set to "Focus", the camera will only capture an image if the AF system obtains focus.

Shutter Release Button

The shutter release button has a two-stage operation: the first is accessed by a gentle half press and activates both the exposure meter and auto-focus. Pressing the button all the way down to the second stage trips the shutter, either immediately in Single, Continuous Shooting or Exposure Bracketing modes, or after initiating a certain action, such as focusing or locking the mirror up for the Vibration Delay (self-timer) mode. If the camera is in Display Off (sleep) mode, a half press will wake up the camera and activate any configured functions. Half press the shutter release can also be used to exit menus and to return the camera to instant readiness.



Secondary shutter release button

This modal button is de-activated by default but when the shutter release function is enabled (from the Top Touch Screen menu), the secondary shutter release button replicates the functionality of the main shutter release button. When enabled, the primary shutter release button remains active, and either button can be used to release the shutter, or initiate a chosen action.

Top Touch Screen

As a multifunction panel the screen layout varies depending on the status of the camera. However, the Classic layout is the main display, and it's here that the camera's exposure values and mode settings are displayed. Shutter speed, ISO and Aperture values are selected directly by the Front, Rear and Side Dials, respectively. Other camera functions, depicted by icons, including capture, metering and AF area modes may be selected quickly via the optional Camera Function settings mode, after pressing the Front Key and scrolling through the options using the Front Dial, or via touch. The Camera Menu display is used to select the less commonly used camera functions. It is accessed via a short press of the Rear Key, and navigated using the Front Dial. Options are chosen using the Rear and Side Dials.



Top Touch Screen

Note the brightness of the Top Touch Screen is determined automatically using a sensor close to the screen, however the brightness setting can be altered via the Rear Key > UI Setup > Backlight



Front Dial

Front Dial

This is used to adjust the Shutter Speed by default, however it is modal, and after pressing the Front or Rear Key it is repurposed for navigation of the Camera Function settings and the Camera Menu, respectively. Note the Front Dial is customizable.



Rear Dial

Side Dial

Side Dial

This is set-up to adjust the Aperture value by default, and is similarly repurposed for making selections from both the Camera Function settings and Camera Menu via the Top Touch Screen. The Side Dial is customizable.

Rear Dial

This dial is principally used to adjust ISO, and like the modal Side Dial, is also used for making selections from both the Camera Function settings and Camera Menu. The Rear Dial is also customizable.



Rear button

Front button

Top Front Key

A short press on the Front Key activates the camera function icons displayed on the Top Touch Screen for quick selection, either by repeated pressing of the key or scrolling with the Front Dial. Note the selection is highlighted in white. Adjustment is made using either the Rear or Side Dial and the depicted function is active immediately.

Top Rear Key

A short press and release of the Rear Key will gain access to the camera menu. When the menu is displayed on the top touch screen, the Rear Key's function is repurposed for navigation and can then be used to scroll down through the menu options (with the Top Front Key used to scroll back up). Note the Front Dial can be used to scroll up and down the menu instead.



On/Off Button

On/Off button

A quick press will power up the camera. The XF start-up logo appears on the Top Touch Screen, followed by the Classic display. If the power level is too low, the battery warning light will flash continuously in red. Otherwise if battery power is sufficient, the warning light stops and the mirror can be heard lowering into position, ready for capture. This behavior is normal, as the mirror is automatically locked up when powered off for peace of mind during transportation. If left untouched, the camera will enter the Display Off (sleep) mode after 1 minute. Simply half press the Shutter release Button to reactivate the display and ready the camera for capture. Note, the delay for the camera to enter the Display Off (sleep) or Mirror Position are all customizable via the Rear Key > Power Management.

The On/Off button is modal and a quick press while in the camera menu will return it to the previous level, including exiting the menu altogether if pressed when navigating the menu at its upper level.

To power the camera down, press and hold the button for 2 seconds. The mirror can be heard being locked safely in position and the IQ back will power down after 3 seconds.



Front User Button

Front User button

This button is by default set to activate the depth of field function. Note continued pressure on the button is required to operate this particular function, but the modal nature of this button means some functions accessed via this button require only a single press and release, for example, when reconfigured for AF-Lock and AE-Lock.



Rear User Button

Rear User button

From the factory the Rear User button is programmed to activate the camera's AE-L (Auto Exposure Lock) function, locking meter readings made in Auto and Manual exposure modes. The Rear User button is customizable,



B.O.B - Cable Release accessory

External shutter release control (B.O.B)

The XF Camera System gives you the option to customize the functionality of the Phase One Break Out Box accessory. This is done by pressing the rear user key and selecting UI Setup > Control Setup > External.

By default it works like a shutter release button, but a particularly useful feature is the ability to activate the two-step mirror control and shutter release instead.

This will make the external button — the B.O.B release button — act with a two shot mirror up function, raising the mirror on the first press, and shooting on the next. You activate the feature by selecting UI Setup > Control Setup > External > MUP-Exp.

Rear	Auto Focus
Front	AEL Toggle
2nd Shut.	Mirror Up
External	MUP-Exp.
Menu Btns.	Up/Down

Mirror Up and Exposure action with External



Customizing buttons and dials

You can customize the functionality of the buttons and dials on the XF Camera to suit your preferred workflow. For example, you might want to control auto focus separately from the shutter release button, or activate Mirror Up or Live View with the push of a button. At the end of this section you will be guided on how to setup some of the most useful customizations.

You can customize all of these buttons and dials on the XF Camera:

- Shutter Release Button (only for the half press action)
- Secondary Shutter Release Button
- Front Dial
- Side Dial
- Rear Dial
- Front User button
- Rear User button
- External Shutter Release (B.O.B.)

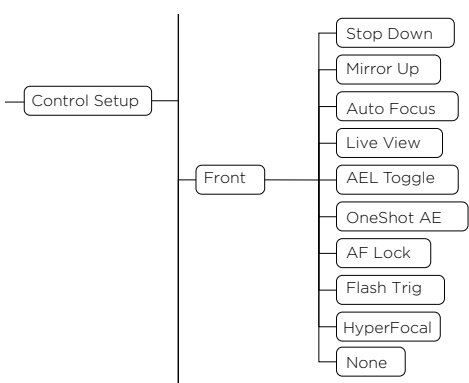

The OneTouch User Interface Flow Diagram section in this XF Manual will show you exactly which functions or actions that can be assigned to each button and dial. Follow the path Rear Key > UI Setup > Control Setup in the diagram and note that the top option in a list is the default setting.

It is worth pointing out that the Front Dial, Side Dial and Rear Dial both have a Primary and an Auto option. Most of the time, the XF Camera will use the assigned Primary option, and the Auto option only comes into play when you are using one of the automatic exposure modes; Aperture Priority (AV) or Time Priority (TV). If you are using Aperture Priority (AV), for example, the Side Dial will control the aperture value and you can then assign the Front Dial to control the Exposure Compensation value. The Auto function can only be set to either control the Exposure Compensation value or engage the Focus Nudge feature.

Changing the function of a dial or button

Press the Rear Key and select UI Setup > Control Setup. Then select the button or dial that you want to customize, and turn the Side Dial until you have selected the desired functionality.

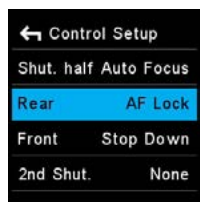

Changing the Control Setup.



Changing the shutter half press action to None.

Remove auto focus from the Shutter Release button

It can be very useful to control auto focus separately from triggering the shutter. With such a setup, you can focus at a certain point of the subject and then take multiple captures by pressing the shutter button repeatedly without having to worry about the camera requiring focus each time.

By default, auto focus is activated by pressing the Shutter Release Button halfway down, so you need to remove this functionality. This is done by pressing the Rear Key and selecting UI Setup > Control Setup and selecting Shut. Half. Then turn the Side Dial until None is selected.



Adding auto focus control to the Rear User Button.

Add auto focus to the Rear User button

If you have removed auto focus from the Shutter Release Button, you need to assign the functionality to another button on the XF Camera. The most convenient to use is the Rear User Button, but you can also assign auto focus to the Front User Button, the Secondary Shutter Release Button or External Shutter Release (B.O.B.).

Auto focus is assigned by pressing the Rear Key and selecting UI Setup > Control Setup and selecting Rear. Then turn the Side Dial until Auto Focus is selected. Auto focus is now activated each time you press the Rear User Button and is in effect locked once you let go of the button.

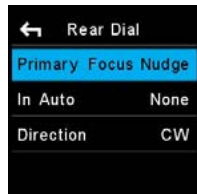

Adding Focus Nudge to the Rear Dial.

Add Focus Nudge to the Rear Dial

If you are working with a very narrow depth of field, it can be difficult to adjust focus with the necessary precision by focusing the lens manually. The Focus Nudge feature is a great way to get accurate focus control, and you just need to assign the feature to one of the three dials to activate it.

It makes the most sense to use the Rear Dial as the Front Dial and Side Dial is used to control the shutter time and aperture. You assign the Focus Nudge feature by pressing the Rear Key and selecting UI Setup > Control Setup > Rear Dial > Primary. Then turn the Side Dial until Focus Nudge is selected.

The Focus Nudge feature is sensitive to the speed with which you turn the dial, so moving it faster will move the focus more than turning the dial slowly. Focus Nudge works particularly well when using live view where you have zoomed in at the point of focus.

Note that the Rear Dial is set to control ISO by default, so you need to change the ISO value another way. This can be done by tapping the Top Front Key until the ISO value is selected and then adjusting the ISO value with the Side Dial.

OneTouch User Interface Flow Diagram

XF Camera Menu Overview

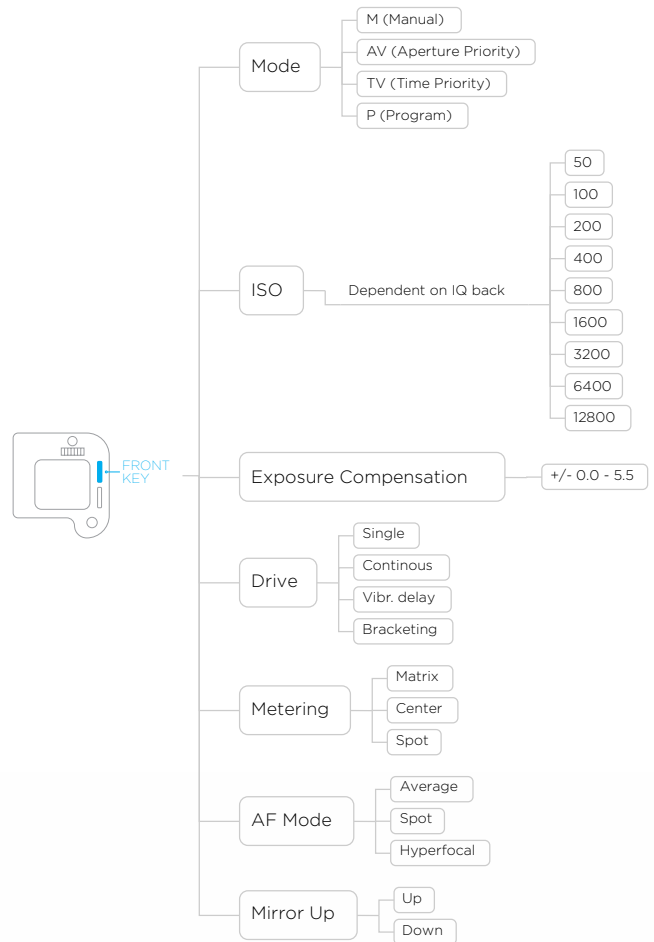

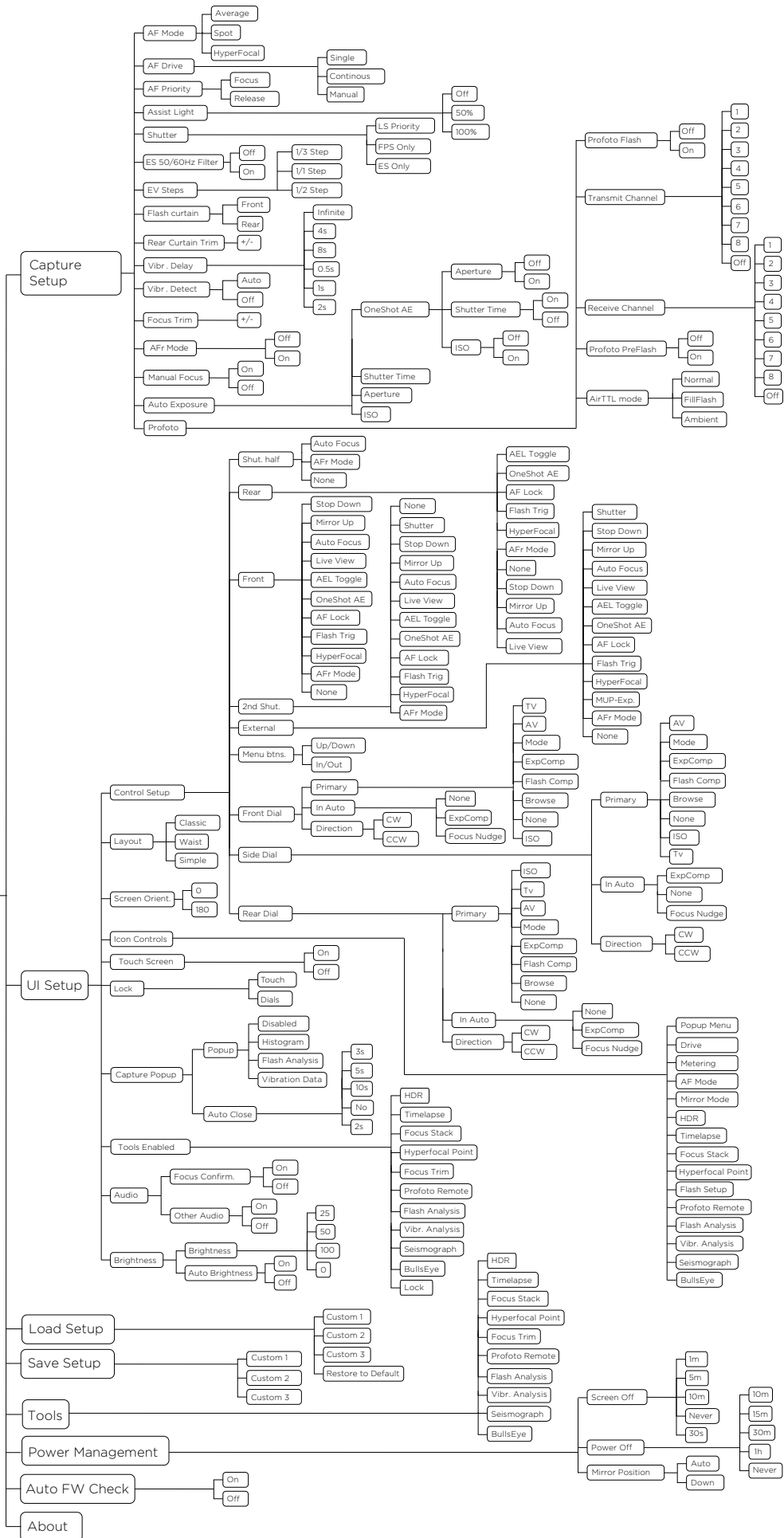
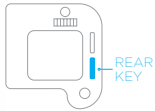

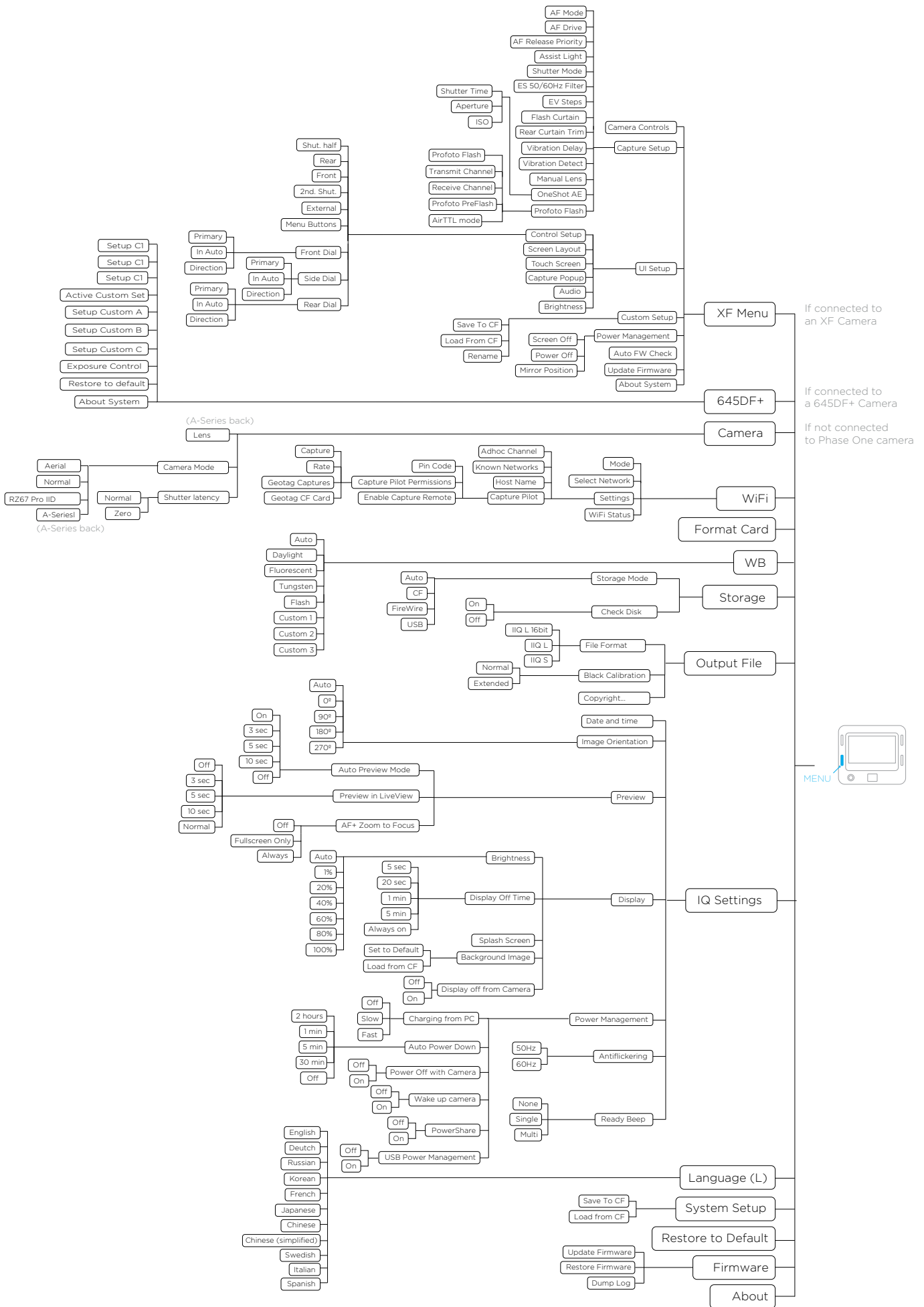

IQ Digital Back Menu Overview



- Long Exposure Mode
- 35
- 50
- 100
- 200
- 200 S+
- 400
- 400 S+
- 800
- 800 S+
- 1600
- 1600 S+
- 3200
- 6400
- 12800
- 25600
- 51200

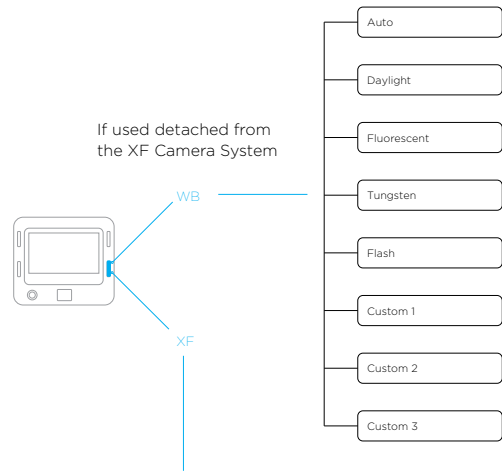

OneTouch User Interface Overview

XF Camera Body Navigation



Top Touch Screen Operation

Dials

The XF Camera System is supplied from the factory in Manual exposure mode with the three dials assigned to the following primary function:

1. Front Dial – Shutter speeds
2. Side Dial – Aperture values
3. Rear Dial – ISO values

Top Touch Screen Operation

All settings and modes displayed in the main panel on Top Touch Screen can be selected and adjusted by touch. Tapping one of the settings or icons will change the display accordingly, see below for more details.

If using the camera in the cold with gloves, for instance, the same settings and modes can also be accessed using the following operation:

1. Front Key – Press for access to Camera Function mode. Press again to navigate to the next setting or mode, or scroll through the settings with the Front Dial instead.
2. Rear Dial or Side Dial – Scroll to make adjustments to the chosen setting or mode. Once selected, no additional confirmation is required.

If operating the camera from the rear, positioned at a high-level on a tripod for example, the main panel can be duplicated on the IQ Touch Screen and operated either by touch or using the IQ back's Rear Keys instead.

User Control Buttons

The User buttons are assigned specific functions from the factory, but can be re-assigned to another function.

1. Front User Button – Press and hold to operate the depth of field preview. The Aperture will close according to the value set on the main display and will remain closed as long as the button is pressed. The Aperture cannot be adjusted while this function is in operation.
2. Rear User Button – Press briefly to lock exposure settings (note when activated, the viewfinder displays the Shutter Speed and Aperture value enclosed by brackets). Press briefly to deactivate the function.

Front and Rear Keys

The Front Key is assigned to access the Camera Function mode, primarily as an alternative to operating the camera without touch (see above).

The Rear Key accesses the Camera Menu system.

Shutter Release Button

Half press activates AF and metering systems. If navigating the menu, selecting functions, or if the camera is in Display Off (sleep) mode, a half press will return the XF to instant readiness.

NOTE:

A secondary shutter release control is available on the front lower-right side, if you want to shoot handheld in portrait orientation or when using the optional waist level finder.

Top Touch Screen Display

Classic Layout (Default)

The XF OneTouch UI is setup by default to display the camera's current configuration using the Classic layout on the top screen. Apart from the Shutter Speed, Aperture value and ISO setting, the Classic layout also displays the Exposure mode, Exposure Compensation, Drive mode, Light Metering mode, Focus Area and Mirror Lock-up setting. Tapping on any item on the screen with your fingertip allows you to set the parameters for that function. Touching the Battery icon will display the camera's status, including the number of shots remaining on CF card. If there's no CF card in the back, the Battery icon is replaced with a flashing red Folder icon as a warning.



Classic Layout (Default)

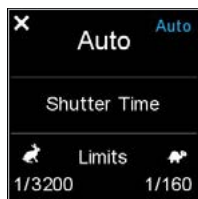

Shutter Time options



Auto ISO options

Auto Functions on Shutter Speed, Aperture and ISO

Tapping on Shutter Speed, Aperture or ISO changes the display and lets you turn on the Auto option for each and set upper and lower limits. For example, you can set ISO to Auto and select a range of ISO settings for the camera to operate within.

Aperture priority is selected by tapping the Shutter Speed setting on the touch screen, and then selecting Auto. If both Aperture and Shutter Speed are set to Auto, the camera will operate in Full Auto (Program) exposure mode.

If Shutter Speed, Aperture or ISO is set to Auto, they will be highlighted in blue on the screen as a reminder. Setting either Shutter Speed or Aperture to Auto mode will also alter the Exposure mode icon in the main display to reflect this change.

If Auto ISO is set together with Auto Shutter Speed or Auto Aperture or both, then the ISO is only changed if a properly exposed image cannot be obtained using Shutter Time range or aperture range.

If ISO is set to Auto, the XF Camera will always try to make an exposure with lowest possible ISO selection.

Simple Layout

A Simple layout is offered as an option from the XF menu (or the IQ XF Camera menu). This layout may be preferred because it displays only the exposure settings (including exposure correction, if set) and battery power level (and camera status). However, touching the exposure scale will display the Drive mode, Metering mode, Focus Area and Mirror Lock-up icons momentarily and allow adjustment, if required.



Simple Layout



Waist level Focus indicator

Waist Level Layout

Waist Level Layout is based on the Simple layout, but with an additional focus confirmation indicator, which is very convenient, when working with the XF Waist Level Finder. With this layout the focus confirmation indicator, known from the prism viewfinder, now appears on the XF top screen and guides you to finding the best focus

Change Screen Layout

Press the Rear Key on the XF top screen and from the menu select UI Setup > Layout > Classic / Simple / Waist.

Note with the Simple and Waist layout you can use the same Auto On/Off feature for the Exposure modes and ISO as in the Classic layout, without having the screen cluttered with settings you rarely change.

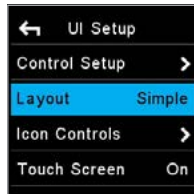

Simple Layout

Screen Orientation

It is possible to turn the screen orientation of the top touch screen 180 degrees. This is done by selecting UI Setup > Screen Orient. > 0 / 180 and causes the screen to be viewed upside-down. Please note that this does not change the assignments of the dials or buttons. The only change is that the dials are reversed within the menu, making it easier to navigate the menu system. The functionality is intended to be used when the XF is mounted in a stand pointing downwards, for example in a copy-stand.



Screen Orientation normal



Screen Orientation at 180 degrees

Sliding in the Lock Functions on the top screen

Swiping your finger from left to right on the XF top screen brings in the Lock Screen. In the lock screen you can toggle touch and Dials on and off by touching the lock icons. Once the Touch is locked none of the touch functions on the screen will respond, except the sliding function that can bring in the tool to unlock again, or give access to display some of the other Tools, but no edits or changes can be made while it is locked.

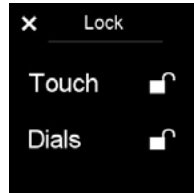

Lock Screen

Customize the Icon Controls

At the bottom of the top touch screen, there is a row of four shortcut icons that makes it possible for you to quickly access certain settings or tools. These icons can be configured to access the tools that you prefer. Press the top rear key and select UI Setup > Icon Controls. Next, select a tool that you wish to enable as a shortcut icon, and turn the Side Dial to choose one of the four positions. Note that you can also change a shortcut icon simply by pressing on one of them on the top touch screen for a few seconds and then choosing the new desired setting or tool from the pop-up window.



Icon Controls pop-up window



Icon Controls

XF Tools on the Top Touch Screen

The XF Camera has a number of highly useful tools that can be a great aid when working with different types of photography. They are all accessed from the Top Touch Screen and are divided into two major types; photographic tools and analysis tools.

The Photographic Tools are:

- HDR Tool
- Timelapse Tool
- Focus Stack Tool
- Hyperfocal Tool
- Focus Trim Tool
- Profoto Remote Tool
- Seismograph Monitor
- BullsEye Level Tool

The Analysis Tools are:

- Flash Analysis Tool
- Vibration Analysis Tool
- Histogram

Swiping to get to the XF Tools

Swiping your finger continuously over the XF top touch screen will reveal the tools one by one in an endless loop along with the screen Lock function. Note that you can also access a Tool by going to the XF menu, selecting Tools and then choose the desired one. This might be a more practical way to navigate the top touch screen if you are wearing gloves.

Switching the XF Tools on and off

Which tools are available on the top screen can be changed in the XF menu system under UI Setup > Tools Enabled. Here they can be switched on and off. If a tool is switched off it will not appear in the loop on the XF top screen.

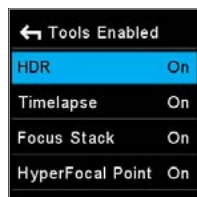

Tools Enabled on Top Screen

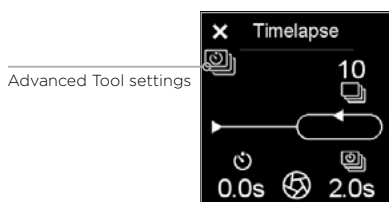

Advanced Tool Options

Note that some of the tools have additional settings that control advanced features. If any of these are available in chosen the tool, an icon will appear just below the close tool icon in the upper left corner. Just tap on the tool option icon in order to access the advanced settings.

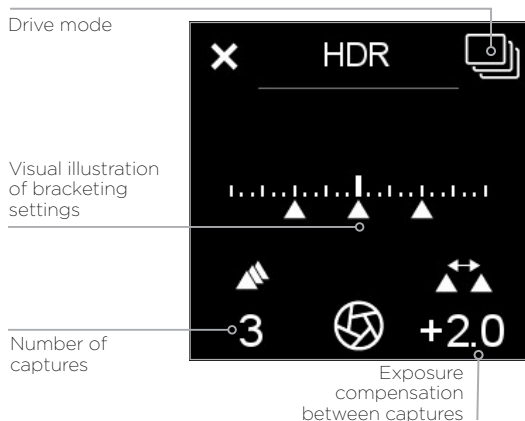

HDR Tool

From the main screen, swiping your finger from right to left on the XF top screen reveals the HDR tool. This tool is essentially the same as the bracketing function on the camera, but with a few convenient extra features attached. HDR Tool will use whatever settings you have setup on your camera, and capture a series of images where it changes the aperture in between.

The HDR sequence is setup using the Rear dial and the Side dial to adjust number of captures and EV deviation between captures.

The Front dial can be used to toggle the vibration delay on and off.

Once the HDR sequence is setup, you press the Rear user button to start capturing the images.

One advantage of using this feature over the standard bracketing mode is that the camera will store Sequence metadata into the files, and thus Capture One Pro can parse these files as part of a sequence, and you can do smart selections or smart albums of all related files.

Timelapse Tool



At second position when swiping to the left is the Timelapse tool.

As with the other sequence tools, metadata is stored in the files to indicate that the files are part of a timelapse sequence, and also which position they are in the timelapse.

Set the number of images you want in the Timelapse using the Front Dial, and the seconds between using the Side Dial.

If you want a delay before the timelapse starts, this is set using the Rear Dial. Image capture is started from the rear button, and images are captured with the current camera settings.

Values that are indicated as red, is out of range - for instance if there is not enough storage for all the images, or the time between each capture too fast for this specific camera-digital back combination or digital back file format setting.

As an advanced feature, it is possible to temporarily suppress the black frame calibration during a timelapse. This is useful when doing long exposures, because the additional time taken by the black frame calibration could end up exceeding the desired time between the captures. Beside the **Normal** operation mode there are 3 other black frame options that can be set:

- **Always.** A black frame reference is generated for every capture.
- **Suppress.** The black frame reference will be suppressed.
- **1st.** The black frame reference is done on first capture, which ensures that reference shot is as close as possible to the capture Temperature and timing of the images in the Time Lapse. With the black reference option set to "1st", the XF Camera will only do a black reference if it is really needed because of significant temperature drift during the time lapse.



Timelapse advanced options

You choose the black reference option by tapping on the advanced tool option icon and selecting the option required with the Side Dial. Once it is active, the suppression is indicated with a red cross over a moon. Please note that the image quality may be degraded as a consequence to selecting "Suppress", but since timelapse sequences are typically used to make videos in a lower resolution, it could often be an acceptable compromise.

Note that the setting will revert back to the Normal black frame calibration between each capture when the camera is turned off.

You can also enable the Electronic Shutter for capturing with the ES in Sequence option. This requires that your IQ Digital Back support the ES feature.

Focus Stack Tool

Focus stacking is especially useful to create macro images with a great depth of field that would not be possible by just stopping down the lens, because that would cause diffraction. There are many ways to compile a Focus stack once the images are captured, one of the best software packages for Focus stacking is Helicon Focus which you can read about at www.heliconsoft.com.

Using the Focus Stack Tool

The Focus Stack Tool is designed to automate the sequence capture involved in making a focus stack of images. The tool will automatically suggest the number of images needed based on the optical quality of the lens, the aperture setting and the area and pixel size of the digital back.

To setup a capture sequence for focus stacking your lens need to be set to Auto Focus. When using this tool the front and Side Dial will adjust the focus of the lens in MCUs (Motor Control Units). Front dial is used for small increments (x 1 MCU), and Side Dial is used for larger increments (x 10 MCU).

1. Setup the near-focus distance using the front and Side Dial. Once you have set the near-focus, store this value by pressing the Top rear key.
2. Then setup the far-focus with the front and Side Dial. Once you have the far-focus adjusted, press the Top front key to store this value.
3. The XF Camera will now automatically calculate the optimal number of images, if your lens support this feature. In this case, the number will displayed in a blue color.
4. If the number of captures is displayed in white, you will need to adjust the amount manually. This is done with the Rear dial.
5. When you are ready to capture, press the Rear User button to start the sequence.



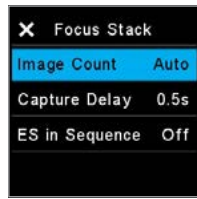

Advanced Focus Stack settings

Note that it is possible to introduce a small delay between each capture when doing focus stacking. This might be necessary when shooting with a flash system that needs a few seconds to recharge. You choose the delay by tapping on the advanced tool option icon and selecting the desired time from Capture Delay, specified in seconds.

The advanced options also let you change whether the tool should calculate the optimal number of images automatically with the Image Count option. Setting this to Manual will disable the auto-calculate feature.

Re-using Focus Stack settings

The Focus Stack Tool will remember the settings used even if the XF Camera have been turned off. The settings will be saved until the lens is changed.

Supported lenses for Automatic Focus Stack Calculator

Currently (as of XF Feature Update #4 SR1) the Automatic Focus Stack Calculator are supported on the following Schneider Kreuznach lenses (both Blue Ring and non-Blue Ring):

- 35mm LS f/3.5
- 55mm LS f/2.8
- 80mm LS f/2.8
- 110mm LS f/2.8 Macro
- 120mm LS f/4.0 Macro
- 240mm LS f/4.5 IF
- Additionally, the Phase One 120mm AF Macro f/4.0 is also supported.

Focus Stack Tool and Capture One

Once you have created the images to be used in the focus stack, you can bring them into Capture One (or if you already shot the images tethered, which is also possible). In Capture One 9.1 and later, you will be able to easily select all images by the Sequence ID metatag created by the XF Camera. Now you can create a smart folder or a selection of these images. When you are done editing, you can output them and stack them using your preferred focus stacking software.



HyperFocal Tool

Hyperfocal Tool

Next to the Focus Stack Tool when swiping left on the XF Top Screen, is the Hyperfocal tool. Hyperfocal tool is designed to set your lens hyperfocal position. The hyperfocal position is the point or marker many photographers set on their lens to easily adjust focus to the hyperfocal distance when shooting landscapes. The Hyperfocal Tool is described in more detail later in this manual. Please read ahead to get more information on this tool.

Focus Trim Tool

This tool will guide you through the process of obtaining the optimal Focus Trim, making sure that the focus system will achieve the best possible accuracy.

Your XF Camera and lenses are manufactured to the highest precision standards, however even slight differences within the tolerances of the autofocus system can lead to the focus being a touch off. The Focus Trim Tool removes this issue by shifting the plane of focus slightly forwards or backwards until a perfect compensation is achieved and stored within the focusing system.

The Focus Trim Tool is disabled by default from the top touch screen because it is not supposed to be used regularly. This means that you need to activate it in the XF menu system under Tools or alternatively enable it under UI Setup > Tools Enabled if you want to be able to use the swipe action to activate it.



Enabling Focus Trim Tool

Use the supplied Phase One Focus Trim Target or download it from www.phaseone.com and print it. Mount the XF Camera on a tripod and make sure that it is perpendicular to the focus target.

Next, make sure that the XF Camera is setup correctly by using the largest aperture of the lens, for example f/2.8, setting the Drive Mode to Vibration Delay, metering to Spot, and AF Mode to Average Focus.

Once you are ready, select the Focus Trim Tool as explained above. Then press Start Tool. The XF Camera will now automatically check whether all the conditions for a reliable focus trim process are met. It will for example check whether the autofocus target has a proper distance, that the amount of light is sufficient and whether the camera can do an auto focus on the target.

If all conditions are met, you are prompted to adjust the focus. This can either be done in Live View, by pressing the Live view button, or by capturing images with the rear user button. In Live View zoom to 100% on the screen. Then move the Side Dial and Front Dial until you have achieved the maximum sharpness. Start with the Side Dial, as it will adjust focus in larger 10x increments, then use the Front Dial for fine-tuning in the smaller 1x increments.

Once done, press Start Trim and the Focus Trim Tool will measure whether the camera can detect focus reliably. If this automatic step is a success, the next step is to save the acquired Focus Trim value by either pressing the Save icon on the touch screen or by pressing the Top Rear Key.

The Focus Trim Tool is described in full detail in the Honeybee Autofocus System section later in this manual.



Start Focus Trim procedure



Adjust focus manually



Start automatic trim



Save Focus Trim value

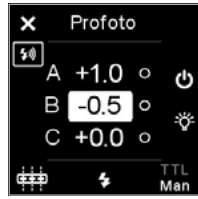

Profoto Remote Tool

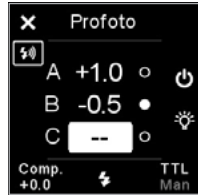

Turning a Flash Group off



Advanced Settings menu for Profoto Tool

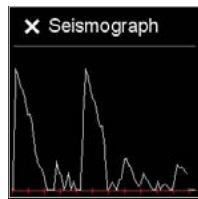

Seismograph monitor

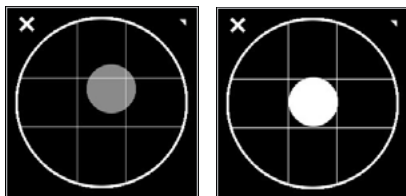

BullsEye levelling tool

Profoto Remote Tool

The XF Camera System can wirelessly control any Profoto Air-enabled flash system through the Profoto Remote Tool. You can swipe with your finger to get to the tool, but you also have the option of assigning it to one of the four shortcut icons in order to access it quickly. Please note that you have to activate the wireless feature by accessing the camera menu and selecting Capture Setup > Profoto > Profoto Flash > On.

You select and move through the different Flash Groups A, B and C with the Front Dial, and then change the selected energy level, indicated in stop increments, with the Side Dial. Note that any changes you make to the energy levels with the Profoto Remote Tool are done as incremental values that add or subtract from the current energy levels on the flash generator.

The top front key will turn the selected Flash Group on and off, while the top rear key will turn the Model Light on and off for the selected group. The rear button on the XF Camera is used to test fire the flash system.

You can change between shooting in Manual mode or TTL mode by turning the Front Dial until you reach the option at the right bottom corner of the Profoto Remote Tool. Then turn the Side Dial to switch.

Note that when Manual mode is selected, the Rear Dial will change the energy level for all Flash Groups at the same time regardless of which group is selected. If TTL mode is selected, the Rear Dial will instead control the flash compensation value. The Profoto Remote Tool is described in more detail in the Flash Photography section later in this manual.

Seismograph Monitor

The XF Camera System is built with precision as a focus. With this in mind, there is an available Seismograph on the XF Camera System OneTouch UI. Like with the BullsEye Level Tool you can bring in this monitor by swiping sideways on the XF top screen. The Seismograph is available to monitor all vibrations which may adversely effect the sharpness of your captured image. The seismograph sensor is also used in connection with vibration delay explained under XF Camera System Capture Modes later in this manual.

BullsEye Level Tool

The XF Camera System includes a BullsEye levelling tool. To activate it you can either swipe it in, by swiping sideways on the XF top screen, or press the Rear Key of the XF OneTouch UI and from the menu select: Tools > BullsEye (select using the Rear Dial and the rear key). The BullsEye tool is calibrated to match the levelling tool found in the digital back's image-tools-list in Play mode. When this tool is accessed for the first time, it is necessary place the XF Camera System on a flat surface (+/- 20°) to facilitate calibration. Calibration is then retained until manual calibration is applied through the 'long press' tool accessed in the upper right corner. this will invoke the manual calibration.

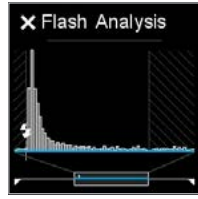

Flash Analysis Tool

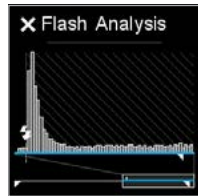

Flash Analysis Tool with flash curtain set to Rear

Flash Analysis Tool

The Flash Analysis Tool can be used by the photographer to verify that the flash light has been fired exactly where it should be during the exposure. The XF Camera System measures the incoming light during the exposure and can display the light energy from the captured image. Note that the flash pulse is shown as a magnified part of the entire exposure. The highlighted selection on the bottom timeline shows where the flash was fired, depending on whether you have set the flash curtain as front or rear. This is done by accessing the camera menu and selecting Capture Setup > Flash Curtain > Front/Rear.

In case the flash curtain is set to rear, the Flash Analysis Tool can be very useful to ensure that all of the light from the flash reaches the sensor before the shutter starts to close. If this is not the case, you can move the flash trigger signal by using the Rear Curtain Trim setting. A negative value moves it earlier, while a positive value moves it later. To find this setting, access the camera menu and select Capture Setup > Rear Curtain Trim.

The Flash Analysis Tool is described in more detail in the Flash Photography section later in this manual.

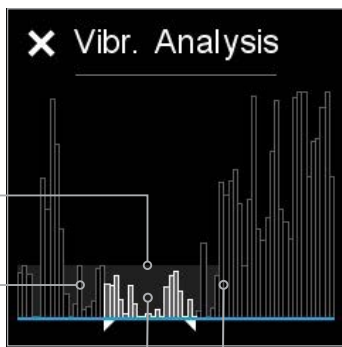

Threshold for acceptable vibration amount

Vibration amount before capture

Vibration amount during capture

Vibration amount after capture

Vibration Analysis Tool

The Vibration Analysis Tool is useful when you want to check whether the capture might have been affected from vibration during the exposure. The information is based on the built-in sensors in the XF Camera that detect rotation and vibration and is available for the latest captured image.

The peaks in the Vibration Analysis Tool represent the amount of vibration during time. The white vibration peaks - encapsulated within the two white markers - represent the exposure time, while the grey colored peaks denote the time just before and after the capture, respectively.

The grey zone at the bottom of the graph roughly represent a safe zone where the amount of vibration shouldn't affect your capture by blurring the image.

It should be noted that it can be difficult to judge whether a capture has been blurred from vibration based on the analysis graph alone. For example, a series of vibration peaks could have a larger blurring effect on the image than a single high peak. When in doubt, you should always check the captured image to see whether it is sharp.

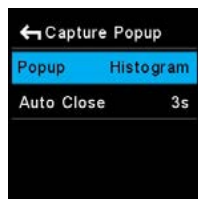

Cature Popup options

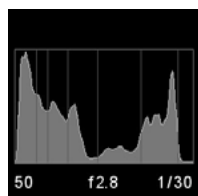

Histogram

Capture Analysis Popup

The XF Camera can automatically show you one of the Analysis Tools on the top touch screen after each capture. You can choose to either get the Histogram, the Vibration Analysis Tool or the Flash Analysis Tool displayed. It is also possible to disable the Capture Popup all together.

You setup the Capture Popup by pressing the Rear Key and selecting UI Setup > Capture Popup. Then select Popup and turn the Side Dial to choose between the four options.

Note that you also have the option to choose how long the Capture Popup should be displayed after each capture with the Auto Close option. If you set the option to No, the chosen analysis tool will be displayed until you touch the top screen or a button or dial.

IQ Digital Back Navigation



IQ Digital Back Overview

Touch Screen Operation

All IQ Digital Backs are equipped with a 3.2-inch touch screen. The touch screen lets you zoom, pan and browse through images quickly, making it easy to navigate between different menus and features. Operation is achieved using the touch screen display or the well known and intuitive, 4-key navigation.

Four Key Navigation

The IQ Digital Back is equipped with four external keys. These keys are modal and will change function to match the menu shown on the display. In addition the function of the four keys changes once one of the Menu, ISO and WB options has been selected. In general, the two keys to the left are used to exit the screen and select a menu option. The two keys to the right are used to navigate up and down.

Home Screen

The IQ Home Screen is the first view users will see when the back is switched on. This is the back's default screen and the starting point from which to navigate the menu system. It enables direct access to the Play mode to view captured images, the Menu to configure the IQ Digital Back's features, and also to select ISO sensitivity and White Balance (WB) settings.

Info Bar

At the bottom of the screen you will find the Info Bar. This displays from left to right: Remaining captures on CF card or host computer, Battery status, WiFi status (if available and turned on), CF card inserted or if a Computer is connected this will be displayed as a USB3 or FireWire symbol. A flashing icon means the function is not available, for instance, "No CF-card" or "No WiFi connection". Far most to the right is the contextual menu. This gives access to many other functions, depending on the IQ model you are using and where you are in the menu context.



Home screen with Info Bar

IQ Digital Back Navigation Shortcuts

Home Screen

A long press on the Upper Left Key will always bring you back to the main menu (Home screen).

Enlarge Playback / Preview Image

When focus-checking images in the Play mode or in Live View, double tap the screen at the point you want to inspect and the image will be displayed at 1:1 (100%) magnification.

Key Lock Shortcut

Press and hold the upper-left (Play) key whilst the Home Screen is displayed and double press the Lower Right Key. A key icon will appear at the bottom of the screen and turn red to confirm that the four (external) menu keys and touch screen functionality has been locked. Repeat the procedure to unlock the keys and screen.

IQ Digital Back Viewing images



Screendump= Screen0531.jpg

Viewing images (Image Playback)

After capture, an image is shown on the rear screen. Image playback can also be accessed at any time from the upper-left key on the IQ Digital Back (this is particularly useful if the screen is in Display Off / sleep mode), or directly from the Play icon on the Home screen.

The default screen is the Tool view mode and is one of three playback modes available: Tool view, Full Screen view and Thumbnail view.

Display Single Image (Tool View)

1. Capture an image, or to view an image already captured, press the top left 'Play' key from the Home screen on the rear touch display.
2. A single image is displayed in the Tool view mode. This mode displays a number of small thumbnail views to the right within which a number of tool options are offered.

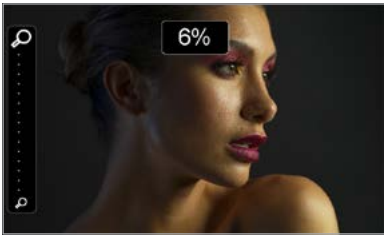

Display Single Image (Full Screen View)

Display Single Image (Full Screen View)

From the default Tool View, tap the main image to display full screen. A zoom scale is displayed to the left of the image, allowing touch screen zooming up to 400%. The Context menu icon is also available (though hidden) at the bottom right. This menu provides access to several tools within the Full Screen View.

Display Multiple Images (Thumbnail View)

Press the Top Left Key on the back to scroll through the playback modes until the Thumbnail view is displayed. Alternatively, access the context menu from the icon in the lower right of the playback screen and tap the Thumbnail icon on the lower row of menu icons.

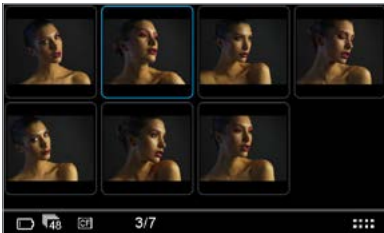

Display Multiple Images (Thumbnail View)

Browsing Images

In both Tool View and Full Screen View, simply swipe between images by sliding your finger left or right over the image. This will scroll forward or back through images in the current folder. You can also use right keys up and down to walk through images.

Focus Checking (Zooming)

In Full Screen View, touching an image will reveal a zoom slider on the left side that can be used for focus checking. Slide your fingertip up or down the scale to zoom in or out, respectively. Drag the image to view other areas. Double tap an image in the area of interest in either Tool View or in Full Screen View, to display that area at 1:1 (100%) magnification. To return to the initial magnification setting, double tap the screen a second time, for instance to select another image, or to check some other area in the same image.

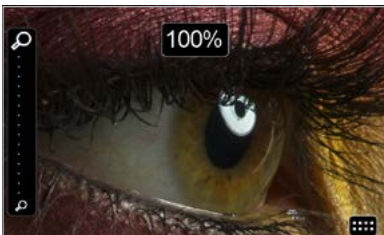

Focus Checking (Zooming)

NOTE:

Once the shutter is released and providing no keys are depressed in the meantime, an image is displayed on the rear screen for approximately 60 seconds, by default. The display time can be altered under Menu>Display>Display Off Time.

IQ Digital Back Contextual Menu



Overview of Contextual Menu

A key feature of navigation on the IQ back is the inclusion of the touch-driven Contextual Menu. This powerful and intuitive feature provides rapid access to some exclusive functions, such as Live View and WiFi, as well as a number of useful tools and shortcuts to frequently accessed functions.

The availability of the different features are based on the context of which the screen displayed. For example, Custom White Balance picker is only available when viewing an image in Full Screen or in Tool View Screen.

Access to the Contextual Menu is gained from lightly touching the Contextual Menu icon located at the bottom right of the Info Bar on the Home Screen, and from the same location in all four screen views (Tool View, Full Screen View, Thumbnail View and Live View).

In addition it is also worth noting the Contextual Menu follows the XF system's general principal of long-pressing icons to access sub-menus. Button icons with a light gray colored triangle displayed in the upper-right corner denote this ability.

Shortcuts to the viewing modes, including Live View, are indicated by the addition of a curved arrow icon in the lower-left corner of the button.

Current contextual position, or indication that a tool is turned on are displayed with a blue dot in upper left corner of the icons.

Features available from the Home Screen

To save power the IQ screen doesn't display the Home Screen continuously and so the Upper Left button must be pressed first. The Home Screen's Contextual Menu icon is displayed in the lower right corner of the screen in the Info Bar. Touching the icon reveals touch-sensitive buttons for direct access to the following features:



Features available In the top row

1. Buttons in the top row:

- Home Screen shortcut
- WIFI (for IQ3 and IQ2 backs)
- B/W Preview
- Lock Screen
- HDMI output (Only available on IQ3 100MP)



Features available in the second row

2. Buttons in second row, are offered for the following:

- Delete option On/Off (Access to delete in Full screen and Tool View)
- Rating On/Off (Access to rate in Full Screen and Tool View)
- Exposure Warning On/Off in all views
- Custom White Balance Picker (Only available in Full Screen or Tool View)
- Grid On/Off (in Full Screen and Tools View)



Features available the third row

3. Buttons in third row, are offered for the following:

- Camera Setup shortcut (XF Camera setup or general camera settings)
- Thumbnail View shortcut
- Tools view Shortcut
- Full screen shortcut
- Live View shortcut

Long Press to get to settings

Some functions have settings that can be adjusted by long pressing on the button. This is indicated in the top right corner with a small light gray triangle. Holding your finger on the button will reveal a settings panel, where the parameters for the function can be setup.

On/Off indication (Position indication)

If a tool is selected or turned on, or if you are located at a location that the button is a shortcut, this will be indicated by a blue dot in the upper left corner of the button.

Shortcut mark

Shortcuts are references to other views, for instance the Home Screen or Tools View. These are indicated by a curved arrow icon in the lower left corner. touching these buttons will instantly bring you to the buttons location.

Tools and settings in View Mode



Using the tools and settings in Tool View Mode

Besides the option to check focus (discussed previously), the IQ has a number of additional tools available from the Play mode to assist photographers while capturing images. After pressing Play, the tools are accessible from the initial Tool View screen as vertically scrollable thumbnails to the right of the playback image.



Exposure Warning

The following tools may be displayed in full screen view, by pressing the relevant tool's thumbnail:

- Histogram
- Alignment
- Exposure Calculator
- Sensor Temperature
- Camera Controls

The following tools are overlaid, by pressing the relevant tool's thumbnail:

- Exposure Warning
- Focus Mask
- File Info
- Exposure Zone

To remove them from the full screen or overlay view, press each Tool's thumbnail a second time.

To re-arrange the order in which the tool is displayed, long press the relevant tool's thumbnail and press the white arrow in the direction required.



Exposure Warning settings with re-arrange Tool order column to the right

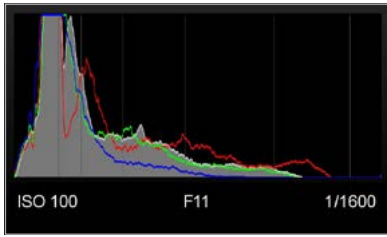

Histogram

Histogram

The histogram displays the brightness data per channel and allows the user to determine a level at which highlights start to clip. For improved accuracy, a custom white balance measurement should be performed.

Press the Histogram thumbnail once to display full screen. The EXIF information (ISO, f-stop and Shutter Speed) of the captured image is displayed below the Histogram. Press the screen again to return to the Tool view. Long press the Histogram thumbnail to access a dialog box to alter the Tool's settings. The user can choose between showing or hiding the RGB readout and EXIF information. To exit, press the Home Key or the small checkmark bottom right.



Exposure and Clip Warning

Exposure and Clip Warning

The Exposure Warning tool highlights areas of a captured image that are overexposed. Press the Exposure Warning tool once to display any burned out areas of an image with a (default red) color overlay. Press the Exposure Warning tool again to remove this overlay from view.

This tool also features a new Clip warning option with a default pink colored overlay based on the raw data for the most accurate visualization of the level at which highlights will clip.

Long press the Exposure Warning to access a dialog box to alter the Tool's settings. Users can choose to set the Exposure and Clip Warning and to flash on the overlay and on the tool. The Highlight level can be changed to make it more or less sensitive. The color of the warnings can also be altered to one of nine tones to help it stand out against a captured image.

The Exposure and Clip Warning overlay can be viewed full screen and zoomed to check specific areas, in the same way as focus-checking. It will flash to alert users to areas in that may be overexposed. To deactivate the overlay, return to the Tool View screen and press the tool.



Focus Mask

Focus Mask

The Focus Mask highlights areas that are in sharp focus. Tap the Focus Mask tool once to display any areas of sharp focus in an image with a (default green) color overlay. Tap the Exposure Focus Mask tool again to remove this overlay from view.

Long press the Focus Mask to access a dialog box to alter the Tool's settings. Users can choose to set the Focus Mask to flash on the overlay and on the tool. The Focus Mask can be adjusted to increase and decrease the threshold setting for the preferred sharpness. The color of the Mask can also be altered to one of nine tones to help it stand out against a captured image.

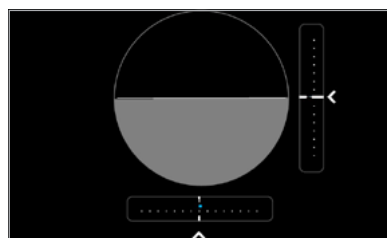

Alignment

Alignment

The Alignment tool provides a quick and accurate visual aid when ensuring the camera is level in both horizontal and vertical planes, and is particularly useful when the camera is mounted on a tripod.

Press the Alignment tool once to view full screen. Tap the screen or press the upper left (external) button to return to the Tool view.

To alter the settings, a long press on the tool's thumbnail will access a dialog box. Users can choose to view a virtual horizon or swap to see numeric Roll and Pitch values instead. To hear an audio alert that signals when the camera is level, enable the Beep On option box with a check mark.

Roll and Pitch offset: It is possible to realign the virtual horizon to a custom setting. Press the Set arrow (see circled far left) and the virtual horizon will appear. Adjust the camera/IQ back for the desired roll and pitch angles and press the green check mark. This offset will be enabled automatically.

Ensure that the Roll and Pitch offset check mark box is not enabled to revert to the default horizontal or vertical alignment setting. Please note that above settings also is used by the BulsEye leveler on the XF Camera Body top screen.



File Info

File Info

The File Info option displays the ISO, f-stop and Shutter Speed settings. Tap the File Info thumbnail to see more detailed information that includes the file name, date and time of capture, file format, exposure mode and the focal length of the lens.

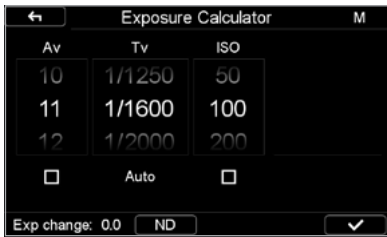

Exposure Calculator

Exposure Calculator

The Exposure Calculator tool allows the photographer to extrapolate Shutter Speeds for long exposures from shorter, equivalent exposure values. This is a useful aid for shortening test exposures, for example, when calculating exposure settings with long exposures at night or when using Neutral Density (ND) filters.

First, capture a test exposure using the widest Aperture available and highest ISO setting (and subsequently the shortest Shutter Speed). Auto exposure and exposure compensation settings may be used to establish the desired exposure. From the Manual exposure mode (if not adopted already), select the Exposure Calculator tool from the Tool View on the rear of the IQ. The calculator is automatically updated with the test exposure values.

To determine the Shutter Speed required, check-mark the box beneath, and then scroll to enter the desired Aperture setting and / or ISO setting. Changing one or more of the settings, after unchecking the box beneath, will display the necessary Shutter Speed and highlight the Exposure (Exp) change in EV (displayed in the Info Bar).

To calculate the exposure before physically applying an ND filter to the lens, touch the ND icon in the Info Bar and select the appropriate ND filter factor from the menu. The calculator will change to reflect the new exposure (if Tv is checked, the Shutter Speed value will alter).

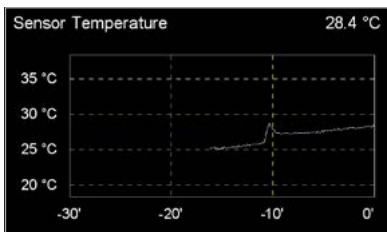

Sensor Temperature

Sensor Temperature

High or low sensor temperatures may adversely affect image quality during long exposures, this tool is useful aid to determine the optimal temperature before capture. A direct readout of the sensor temperature is available from the Tool View and a graph of the temperature over elapsed time is displayed in Full Screen View. To display the graph, select the tool from the Tool View mode and wait for the temperature to stabilize before capturing long exposures.

This tool will also help to determine when a stabilized temperature is reached after extensive use of Live View.



Exposure Zone

Exposure Zone

This tool displays a visualization of the dynamic range of the image captured based on the raw luminosity data, and is useful in determining the absolute point at which highlights will clip. It can also be a valuable tool when deciding how shadows are to be rendered. Color tones are used to indicate the dynamic range in EV. Press the thumbnail to display an overlay in full screen view and press again to display the EV scale (a second press reveals a scale using brightness (luminosity) values). Press and hold to display a General Guide to the scale. To remove the guide, press the checkmark, bottom right.



Camera Controls

Camera Controls

When attached to the Phase One XF Camera Body, the IQ Digital Back can display the camera's control screen, making it easier when working from behind the camera. All the controls may be activated by touch, including the Live View, AF and Shutter Release buttons displayed alongside, to the right.

Camera Controls are also accessible directly from the Home Screen, by selecting the XF button.

Prism Viewfinder Display and Functions

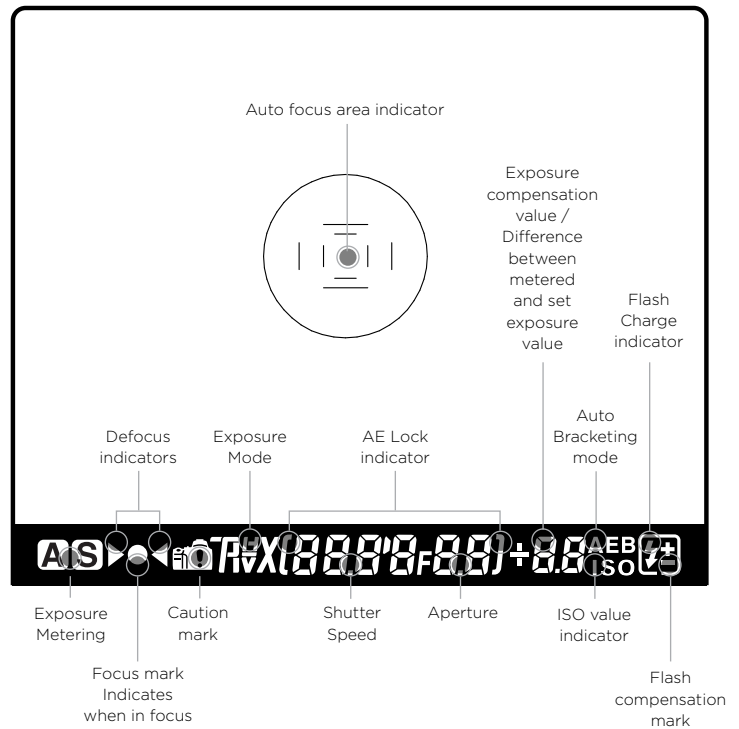

Viewfinder Overview

Autofocus Area

The XF is equipped with autofocus sensor indicators in the center of the frame. Two rectangular AF areas are displayed on the focusing screen, one within the other, that corresponds to the Average and Spot AF mode options available with the camera. Surrounding the AF area is a central spot that denotes the Spot metering area only.

The AF area in use is highlighted on the XF Top Touch Screen. To change the AF area mode, touch the icon, and select the appropriate area option from the screen.

Viewfinder Display

The XF has a comprehensive viewfinder display. However, for clarity only relevant information is shown. Please refer to the image above for an explanation of each possible display settings.

Eye-piece Diopter Adjustment



Eye-piece Diopter Adjustment

Adjustment is required for comfortable viewing if you wear corrective lenses. To start the procedure, first switch the lens to MF and defocus the lens manually. Point the camera at a bright, evenly lit area such as the sky or a white wall. Look through the viewfinder and turn the diopter adjustment dial on the side of the prism viewfinder until the AF area frames and Spot metering circle on the focusing screen are in sharp focus. Turning the diopter adjustment dial counter-clockwise adjusts for near-sightedness, clockwise for farsightedness.

If you normally wear eyeglasses for distance viewing, or close-up work, and want to continue to wear them while using the camera, follow the procedure described above. Alternatively, if you prefer to remove your eyeglasses while working with the camera, please repeat the method of adjustment above without wearing them.

If the built-in diopter is not sufficient, you may require an optional diopter correction lens:

- Part# 70278 Diopter correction lens DE402 (Near Sighted, -5 to -2 diopter)
- Part# 70279 Diopter correction lens DE403 (Far sighted, 0 to +3 diopter)

For replacement of the supplied diopter correction lens, please order:
Part # 70277 Diopter correction lens DE401 (Standard, -2.5 to +0.5 diopter)

Removing the Eyecup

The eyecup supplied with the XF as standard is suitable for users who intend to use the camera either with or without eyeglasses. To replace the factory diopter, release the eyecup by pulling the small metal latch on the top towards you. Then slide the eyecup up and out of the eyecup rail.

Changing the Viewfinder Diopter Lens

To change the diopter correction lens, first remove the eyecup then gently slide the diopter lens down, and out of the diopter rail. Reinstall the new diopter lens, and make sure it is positioned back correctly with the small click-lock tab facing up on the left-hand side.

Viewfinder eyecup release nub



NOTE:

If there is dirt or dust on the lens surface, remove it with a blower or sweep it off gently with a lens brush. If there are fingerprints or dirt on the lens surface, wipe them off with a piece of clean, soft gauze. Using solvents could discolor the correction lens frame.

XF Camera System Settings Overview



XF Camera Body basic settings

The XF is delivered from the factory preconfigured with a set of default settings. The XF Camera Body can be reset to the default settings from the Camera menu, Load Setup > Restore to Default.

Shutter Speed

Shutter Speed can be adjusted using the Front Dial.

Aperture

Aperture can be adjusted using the Side Dial.

ISO Selection

ISO can be adjusted using the Rear Dial. ISO speed options are dependent on which IQ back is attached. Auto ISO speed range can be selected by touch, and is also dependent on the IQ Digital Back attached.



UI Setup Menu



Control Setup

Any one of the three dials may be reconfigured to adjust Exposure Compensation in Auto mode (Off by default). This option is selected by pushing the Rear Key to enter the Camera menu and selecting:

UI Setup > Control Setup > Front / Rear / Side Dial > In Auto > ExpComp.

All three dials turning direction may be reversed by pushing the Rear Key to enter the Camera menu and selecting:

UI Setup > Control Setup > Front / Rear / Side Dial > Direction > CCW (default) / CW.

Please note the symbol (/) denotes an optional setting.



AF Drive Single

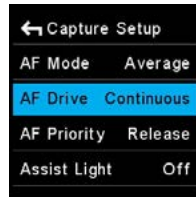

AF Drive Continuous

AF/MF

Autofocus or Manual focus operation is selected using the physical Auto/Manual collar on the lens.

AF Drive Mode

The AF drive mode can be changed by pushing the Rear Key to enter the Camera menu and selecting Capture Setup > AF Drive > Single (default) / Continuous.



AF Area Mode

AF Area Mode

The autofocus area can be set to Average (default), Spot or HyperFocal by selecting the icon on screen and choosing the required mode by touch or the Side Dial.



Capture Mode

Capture Mode

The capture mode can be changed by selecting the icon on screen and choosing the mode by touch or the Side Dial. You have six options to choose from: Single (default), Continuous, Vibration Delay, Bracketing, Delayed and Manual (Bulb/Toogle).

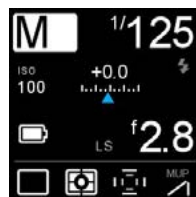

Exposure Mode

Exposure Mode

Manual (default), Aperture Priority, Time (Shutter) Priority and Program exposure modes can be changed by selecting the icon on screen and adjusting by touch or the Side Dial.



Metering Mode

Metering Mode

Select one of three modes for reflected, ambient light only. Choose between Matrix (default), Center and Spot, by selecting the icon on screen and choosing the required mode by touch or the Side Dial.

Note modes depicted by screen icons can be selected directly by touch or by pressing the front Top Key and then by scrolling through the various icons using the Front Dial.

IQ Digital Back Basic Settings



Home Screen



WB selection

Basic settings

At the Home screen, WB, ISO and File Format are displayed at the center of the screen in order to always give a clear indication of what these important settings are.

ISO

The sensitivity range is dependent on the IQ Digital Back model. The default setting for the IQ Digital Back is always the lowest ISO position. This ensures the best possible image quality output, when the Digital Back is reset to default.

Choose the appropriate ISO value by selecting ISO from the Home Screen. Or using the Rear Dial on the XF Camera.

White Balance

There are four White Balance presets plus an Auto option, that can be selected directly from the Digital Back Home Screen. Choose between Auto (default), Daylight, Fluorescent, Tungsten and Flash. It is also possible to create a custom White Balance please refer to Custom White balance section in this manual.

Choose the appropriate white balance by selecting WB from the Home Screen

Restoring the defaults

The IQ Digital Back is supplied preconfigured with a number of default settings ready for use, either when purchased by itself, or with the XF. After adjustment of these settings, you can restore the back to the factory defaults from the back's screen by pressing Menu > Restore to Default. As a convenient feature, you have the option to choose whether the current copyright information, splash and background screens, custom white balance values and WiFi settings should be reset or kept during the restore. This feature is described in more detail later in this manual. Note the Language and Date and Time remain unaltered.

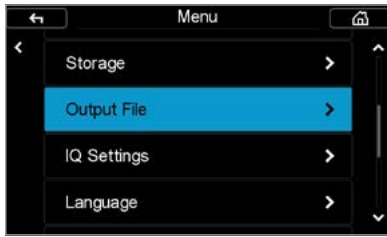

File Format



IQ3 100MP IIQ L 16bit File Format

File Formats

Phase One has engineered a very clever RAW file format compression that we named Intelligent Image Quality (IIQ). Two types of compression are used, a completely lossless format "IIQ L" and a near lossless compression "IIQ S".

All IQ Digital Backs features output of the two RAW file formats IIQ L and IIQ S.

The IQ3 100MP has an additional third IIQ L 16bit file format described below.

IIQ L and IIQ L 16bit are both completely lossless RAW formats designed for the highest quality output (default).

The IIQ S option delivers a "Smart" compressed RAW file format, which with its compression provides a faster capture rate and improved workflow.

However IIQ S is not completely lossless, but rather what we call near lossless.

Choose between formats by selecting Menu > Output File > File Format > IIQ L 16bit/ IIQ L / IIQ S.

Why IIQ L 16bit?

Both IIQ L and IIQ S are 16bit file formats when using CCD digital backs (IQ3 80MP/60MP, IQ280/260, IQ180/160/140).

The 50MP CMOS based digital backs (IQ3 50MP, IQ250 and IQ150) output 14bit data in IIQ L format.

The IQ3 100MP features a new and Improved CMOS file format "IIQ L 16bit". The IIQ L 16bit is, similar to the IIQ L, a completely lossless file format. It handles output in full 16bit from the IQ3 100MP CMOS sensor which is a new feature introduced with this special CMOS sensor.

While IIQ L 16bit provides the ultimate quality possible from the IQ3 100MP, the file size is also larger and the capture rate slower when compared with the IIQ L or IIQ S.

NOTE:

The IIQ S option can be used in almost all applications where it provides a completely sufficient quality - in fact the "Smart" compression is so good that it can be difficult to see a difference. However, there is a very small loss of data, and therefore Phase One does not claim that IIQ S is completely lossless, but only what we call "near lossless"

Custom White Balance

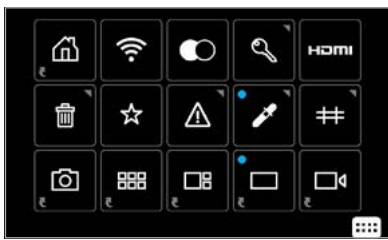

Custom White Balance in Contextual Menu

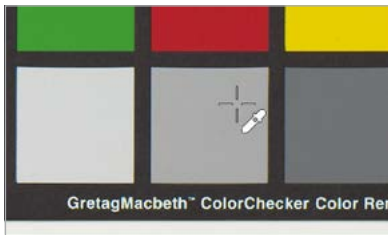

White balance picker

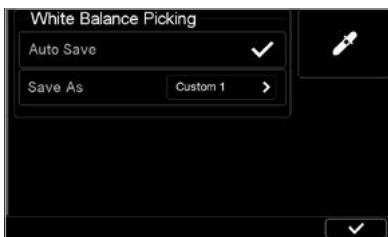

Store Custom White Balance Settings



Custom white balance selected

Creating a Custom White Balance

Creating a custom White Balance setting is achieved from a captured image when in the play mode on the IQ Digital Back. Select Auto WB or use one of the four Presets and capture a reference White Balance image (ideally with a Gratac Macbeth Color Checker, or QP-Card displayed in the image under the intended light source). Tap the displayed image, or press Play, then tap the image again to enter the Full Screen view on the IQ display. Touch the small contextual menu icon in the lower right-hand corner of the screen to display the Contextual menu and press the White Balance Picker button. Zoom in and pan to a desired part of the image using your finger-tip and then tap on a gray patch, or a bright white or gray neutra area in the image (i.e. not burned out area) to create a custom white balance.

A cross-hair icon will appear on the screen. If necessary, you can continue to select the white balance point elsewhere in the image until you are satisfied with the resulting white balance. The setting is automatically saved and all subsequent captures will use this white balance setting (see note, below).

Saving Custom White Balance Settings

The IQ back enables photographers to create and store up to 3 Custom White Balance settings. From the Context menu, long press the White Balance Picker icon and de-select the Auto Save box in the dialog box.

The next time you create a Custom White Balance setting you will be asked to Save WB and presented with a Custom 1, Custom 2 or Custom 3 option. Choose a number to save and store the setting. This stored setting can be accessed again for future use by scrolling to the bottom of the white balance options.

NOTES:

The custom white balance is only applied to the current image if the Auto Save mode is selected.

White balance and custom white balance settings are really only necessary for a representative rendering of the color when displayed on the rear touchscreen of the IQ Digital Back. The IQ Digital Back does not process JPEGs in-camera and the default IIQ L and optional IIQ S file formats contain all the relevant information required for correction in Capture One, especially when capturing a reference white balance file with a gray card under the intended light source.



Honeybee Autofocusing System

The Honeybee Autofocus Platform is designed with a custom processor coupled with a dedicated high-resolution CMOS sensor. This combination creates a unique floating-point architecture and a fully programmable interface, making the Honeybee Autofocus Platform easy to expand, update and customize.

Honeybee Autofocus Platform versions

In mid 2017, Phase One introduced an optional upgraded version of the Honeybee Autofocus Platform, called HAP-2. The new HAP-2 sensor has increased sensitivity and improved dynamic range, making it superior to the HAP-1 sensor in low light situations and on low contrast targets. This means that the XF Camera with HAP-2 installed is capable of using auto focus in available light situations where it previously could be challenging. (With HAP-2 the minimum EV for auto focus is reduced from 4.0 to 1.5). Apart from the increased sensitivity, all AF functionality in the XF Camera is available with both the HAP-1 and the HAP-2 AF sensor.

Note that it is possible to have your XF Camera upgraded to the newer HAP-2 focusing unit by a Phase One service center, if desired. Please contact your Phase One Partner for details.

If you're in doubt of which version of the Honeybee Autofocus Platform your XF Camera have installed, press the Top Rear Key and select About. The information screen will either state HAP1 or HAP2 under the AF item.

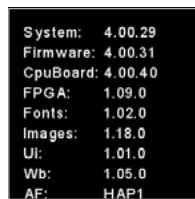

Installed HAP version



Focus Modes

Focus Modes

There are two autofocus mode (AF Drive) options available from the XF Camera Body: Single and Continuous. The camera is delivered with the AF Drive mode set to Single and the AF Priority function set to Release (release priority) by default. The focus point is determined by the AF Area mode displayed as inner and outer brackets on the focusing screen. When contrast or light levels are too low, the AF Assist Light may be activated. It is set to Off by default (from the camera menu, select Capture Setup > Assist Light > On).

AF Drive mode setting

To change between Single and Continuous AF, press the Rear Key to enter the Camera Menu and select Capture Setup > AF Drive > Single / Continuous, using the Front and Rear Dials.

Single (AF)

Selecting the Single AF drive mode activates the AF servomotor to focus the lens once, after pressing the shutter release button halfway. After focus has been achieved, maintaining pressure on the shutter button at this half-pressed stage locks the focus, allowing the photographer to recompose the image. Pressing the shutter release button to the second stage releases the shutter. Autofocus is reactivated by releasing the button and half-pressing again.

Continuous (AF)

Choosing the Continuous mode, with the shutter-button pressed halfway, the AF servomotor focuses the lens while the Honeybee autofocusing system continues to monitor the subject. If the subject moves after being acquired, the



Single (AF)



Continuous (AF)

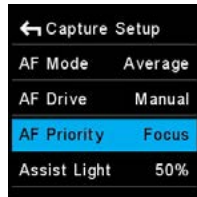

AF Priority setting

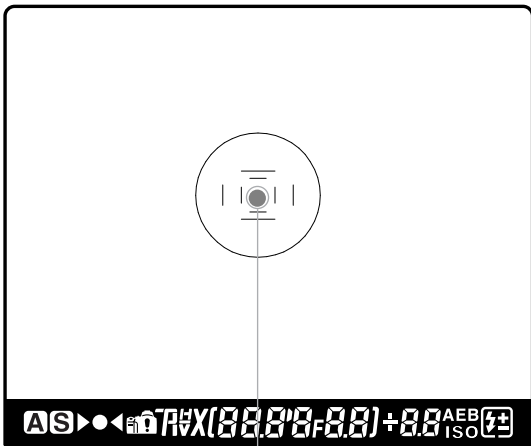

Auto focus area frame

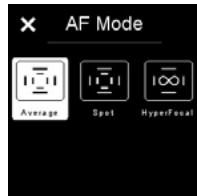
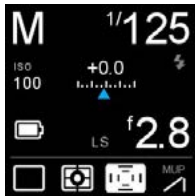

AF Area Mode setting

lens will be refocused to follow the subject.

AF Priority setting

The AF priority can be set to prevent the shutter from being released until the subject is confirmed as in focus. To change AF Priority, press the Rear Key to enter the Camera Menu and select Capture Setup > AF Priority > Release / Focus.

AF Area Modes

Autofocus precision and accuracy are essential to deliver sharpness at high-speed, and so Phase One developed a proprietary autofocus sensor for the XF Camera, the Honeybee Autofocus Platform, and equipped it with a dedicated processor. For improved focus precision, the XF Camera replaces individual line and cross-type sensors in favor of a single CMOS sensor containing a million pixel elements arranged in a multiple honeycomb-shaped pattern. For optimal autofocus with a variety of subjects and scenes, the Honeybee Autofocus Platform sensor has two AF Areas, Average and Spot. Note the AF system is located in the mirror-box and operates when either the prism viewfinder or the waist level finder are attached.

Average AF Mode

The Average mode covers the largest area for focusing and takes advantage of all one million (1MP) pixel elements. The Area covered is displayed in the center of the viewfinder and is represented by the outer-brackets etched onto the focusing screen. The Average mode can be used with long lenses and small Apertures in low light levels. Choose this mode where manual focusing may be difficult during hand-held capture, or when photographing a moving subject.

Spot AF Mode

The Spot AF mode covers a much smaller area in the center of the viewfinder, and is indicated by the narrower brackets on the focusing screen. Select this mode when working with wide-angle lenses, or for pinpoint focusing with longer focal length lenses.

AF Area Mode setting

To change from the default Average area to the smaller, Spot AF area, select the AF mode icon from the Top Touch Screen and then switch between the settings directly, using touch (or the keys, as described elsewhere). The mode selected is shown on the Top Touch Screen.

NOTE:

If the lens ring is set to AF pressing the shutter release button activates autofocus. With the subject covered and acquired by the selected AF area, the focus confirmation indicator lights in the viewfinder when focus has been achieved. Audio confirmation is off by default but to turn this option on, press the Rear Key to enter the Camera Menu and select UI Setup > Audio > Focus Confirm. > On.

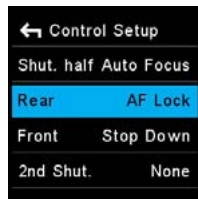

Assigning AF Lock

AF-Lock

When the camera is set to either the Single shot or Continuous AF Drive mode, the focus position can be locked, which is useful for off-center subjects. The AF-Lock function is not assigned to a control button by default. To re-configure the Front or Rear User button, or assign the feature to the secondary shutter release button, press the Rear Key and select UI Setup > Control Setup > Rear / Front / 2nd Shut > AF Lock.

1. Focus on the subject using the Single shot or Continuous AF Drive mode.
2. Press and hold the assigned button to lock the focus.
3. Recompose the subject in the viewfinder.

NOTE:

You will achieve higher focus accuracy for off-center subjects by using the dedicated focus recompose feature called AF+, which is described in a later section.



AF/MF selector ring

Manual Focus (MF)

Manual focus is achieved by switching the AF/MF selector ring on the lens from AF to MF. Note autofocus cannot be performed if the lens is set to MF. The point of focus can be determined by the AF Area mode using the focus indicators in the viewfinder display, or by eye using the focusing screen.

NOTE:

The AF/MF selector ring on the lens can help you to rapidly switch between AF (Autofocus) and M (Manual) using your left hand, without having to remove your finger from the shutter release button.

AF Compensation with Focus Trim

It is possible to fine-tune the AF sensor's accuracy with two methods. You can either use a fully manual procedure as described on this page, or use the semi-automatic way with the Focus Trim Tool as described in the following chapter. Phase One recommends that you use the Focus Trim Tool.

The Focus Trim feature adjusts the plane of focus forwards or backwards by the set amount and the focus point will then be adjusted by this trim amount every time autofocus is initiated.



Focus Trim setting

Adjusting Focus Trim manually

Phase One recommends making adjustments using the Spot AF mode with the camera and intended lens on a tripod, either at the location (under the anticipated lighting conditions), or at a similar distance with as close to the anticipated conditions as possible.

To set the amount of front or back focus compensation, press the Rear Key to enter the Camera Menu, and select Capture Setup > Focus Trim > - / 0 / +. The amount can be adjusted in steps of ± 5 pts.

Make initial adjustments in multiples of three (± 15 pts.) or five steps (± 25 pts.) and then fine-tune in smaller steps until the desired result is achieved.

Setting negative (-) Trim values moves the focus point forwards of the default (factory set) focus point (0). Selecting positive (+) Trim values moves the focus point backwards of the default focus point (0). Therefore, if the focus point is in front of the intended point of focus, continue to adjust by increasing the positive (+) value.

To remove the compensation settings, set the Trim value to zero (0).

Focus Trim Tool

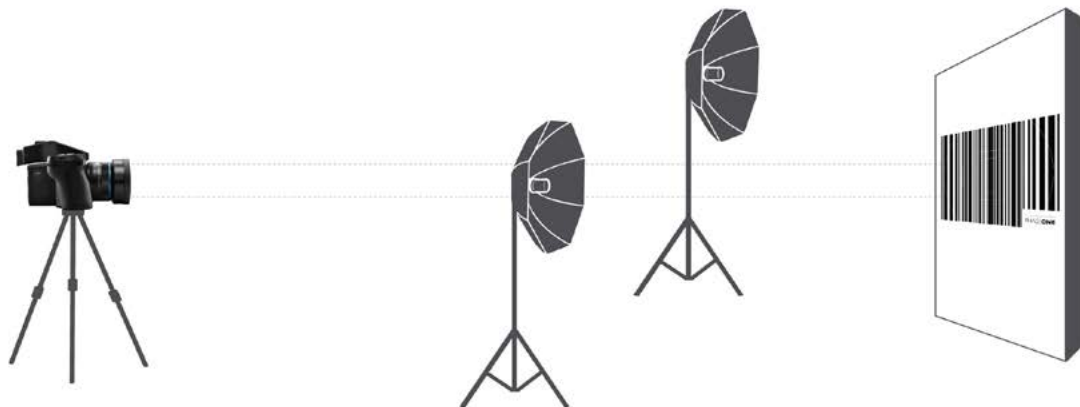

This tool will guide you through the process of obtaining the optimal Focus Trim, making sure that the focus system will achieve the best possible accuracy.

Your XF Camera and lenses are manufactured to the highest precision standards, however, even slight differences in the tolerances of the autofocus system can lead to the focus being a touch off. The Focus Trim Tool removes this issue by shifting the plane of focus slightly forwards or backwards until a perfect compensation is achieved and stored within the focusing system.

The Focus Trim Tool is a five-step guide that makes the process both easy and reliable. The tool is disabled by default from the top touch screen because it is not supposed to be used regularly. This means that you need to activate it in the XF menu system under Tools or alternatively enable it under UI Setup > Tools Enabled if you want to be able to use the swipe action to activate it.



Step 1: Preparation and setup

Use the supplied Phase One Focus Trim Target or download it from www.phaseone.com and print it. Mount the XF Camera on a tripod and make sure that it is perpendicular to the focus target.

You will get the best result by using the same distance between the camera and the Focus Trim Target that you would normally shoot with. For a more universal setting, adjust the distance so that the markers in the viewfinder more or less matches the corresponding white markers on the A5-sized Focus Trim Target.

Next, make sure that the XF Camera is setup correctly by using the largest aperture of the lens, for example, f/2.8, setting the Drive Mode to Vibration Delay, metering to Spot, and AF Mode to Average Focus. Pay attention to the exposure if you are in Manual mode, and adjust the shutter speed until you have a slight overexposure.

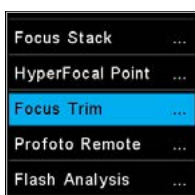

Selecting Focus Trim



Start Focus Trim

Once you are ready, select the Focus Trim Tool as explained above. Then press Start Tool.



Not enough light on focus target



Focus target is too far away

The XF Camera will now automatically check whether all the conditions for a reliable focus trim process are met. It will, for example, check whether the autofocus target has a proper distance, that the amount of light is sufficient and whether the camera can do an auto focus on the target.

The tool will warn you if certain conditions are not fulfilled, like the light level on the focus target being too dim. If you get any warning, you should fix those, and start the Focus Trim Tool again.

Step 2: Adjusting focus manually

If all conditions are met, you are prompted to fine-tune the focus manually until the target appears as sharp as possible. This can be done using either Live View on the IQ Digital Back or connecting the XF Camera System to Capture One Pro.

2a: Using Live View on the IQ Digital Back

Tap on the Live View icon in the Focus Trim Tool to activate it on the IQ Digital Back. Zoom to 100% on the screen in order to see the focus target clearly. It is important that you zoom into the same center area on the target that the XF Camera has focused on.

Adjust the Side Dial and Front Dial until you have achieved the maximum sharpness. Start with the Side Dial, as it will adjust focus in larger 10x increments, then use the Front Dial for fine-tuning in the smaller 1x increments.

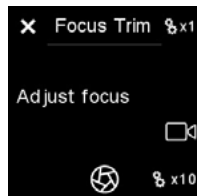

Adjust focus manually

Once you have achieved maximum sharpness, exit Live View on the IQ Digital Back by pressing Live View icon again. Then proceed to step 3.

2b: Using Capture One Pro

It is easier to do the manual focus fine-tuning step using Capture One Pro for a couple of reasons. Adjusting the focus from the software will ensure that the camera doesn't vibrate during the action and will provide a steadier Live View feed. You can also zoom in closer with Capture One Pro and use the Live View Focus Meter Tool to help achieve the optimal sharpness.

In Capture One Pro, go to the Camera Tool under Capture Tool Tab and click on the Start Live View button. Make sure that you zoom into the same center area as the XF Camera has focused on. You might need to adjust the Lightness slider in the Live View Controls to brighten the Live View feed.



Start Live View



Brighten the live view feed with Lightness

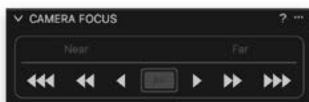

Using Camera Focus to adjust focus manually

Use the Camera Focus Tool to adjust focus manually by clicking on the arrow buttons until you have achieved the maximum sharpness. You should first use the buttons with double-arrows, and then fine-tune focus by using the single-arrow buttons.

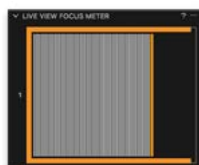

Live View Focus Meter Tool

The Live View Focus Meter Tool can help you to achieve the optimal sharpness. Click on the Focus Meter icon and place the frame over the central focus area. Click on the buttons with the single-arrow in the Camera Focus Tool until the orange border is as far to the right as possible while it is also filled with white stripes. This will be the point of optimal sharpness.

Once done, close the Live View window in Capture One Pro.



Start automatic trim adjustment



Measuring the focus trim value

Step 3: Start automatic trim

Press the Start Trim or the Top Front Key. The Focus Trim Tool will now measure whether the camera can detect focus reliably with the adjustments you have made in step 2. If all is well, the progress bar will be green, and the Focus Trim Tool will move to the next step where you can save the focus trim.

If the measurements fail, the bar will turn red. This can be caused by low light on the focus target, and you should rerun the process.



Saving the Trim value

Step 4: Saving the auto focus trim value

Save the obtained Focus Trim value by either pressing the Save icon on the touch screen or by pressing the Top Rear Key.

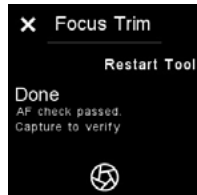

Verifying the trim value

Step 5. Done

It can be a good idea to verify the new focus trim value by capturing an image while still in the Focus Trim Tool. This is done by pressing the Rear User button. Then check the sharpness of the image on the IQ Digital Back by zooming in to 100%.

If you want to rerun the Focus Trim procedure, press the Restart Tool or the Top Front Key. The tool is closed by pressing the cross in the upper-left corner.

Autofocus & Recompose mode / AFR Mode

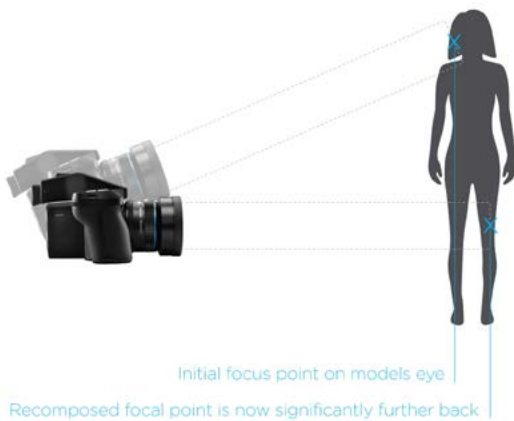

The XF Camera has a unique auto focus feature called AFR Mode which will ensure the intended subject remains in focus even after you lock focus and then recompose the image.

Under normal circumstances, the plane of focus will shift when you change the angle of the camera for recomposing after having locked focus. This will render the intended subject slightly out of focus, which is especially notable if you are working with a shallow depth of field. A classic example of this is found in portrait photography where you lock focus on the subjects eye, using the center auto focus point, and then recompose the frame so the subjects eye is no longer in the center of the image. The resulting image will result in the eye then be slightly soft as the plane of focus is moved (behind the eye or in front of the eye).

Using AFR Mode compensates for this movement of the focus point, making sure that the eyes – or another subject – retains focus after the frame is recomposed. The XF Camera uses internal sensors to calculate the compensation, measuring both the distance to the subject and the degree to which the camera is moved from the point where focus was acquired to the point where you capture the image.

This feature is optimized for speed and performance in a professional working environment. As such, the compensation that AFR Mode applies to your captured image is anticipated based on your preceding captures. In this way AFR Mode can effectively learn your specific technique and improve as you continue to capture. The initial act of focusing on a subject and recomposing the frame is steadily improved while using this auto focus feature, providing (optional) audio and visual feedback to verify success.



Enabling AFR Mode



AFR Mode active

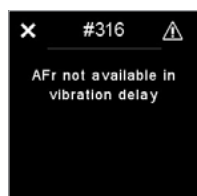

Vibration Delay warning

Enable AFR Mode

You can enable AFR Mode by pressing the Top Rear Key and selecting Capture Setup > AFR Mode. Then adjust the Side Dial to turn the feature On. Please note that the lens will now refocus as a part of a calibration; this is a normal behavior.

Once you have enabled the AFR Mode, an AFR icon will show up on the top touch screen to remind you that the feature is active.

Note that Vibration Delay cannot be used in conjunction with the AFR Mode because both features rely on the 3D movement sensors in the XF Camera. If you have activated Vibration Delay, you will get a warning message, asking you to turn it off in the Drive setting.

Using AFR mode to recompose

Once AFR mode is activated, autofocus is invoked by pressing the shutter button halfway down (unless autofocus function is assigned to a separate button). When you have locked focus on the target, simply recompose and press the shutter button all the way down to capture the image. The XF Camera will automatically adjust the plane of focus for you, based on your anticipated movement, prior to capturing the image.

Feedback on focus accuracy

The XF Camera can give you visual and audible feedback to reflect the success, or failure, it was able to measure in maintaining focus on the subject after recomposing. The focus indicator in the viewfinder will blink once if the operation of AFr was correctly anticipated and verified, while both the focus dot and the arrow indicators will flash quickly if the camera cannot verify that accurate focus and recompose was achieved.



Enabling focus confirmation beep

If you have enabled Focus Confirm under Audio, the XF Camera will also give you audible feedback. You will get a normal sounding beep if the focus and recompose operation was measured as a success, while you will hear a longer sounding warning beep if the camera cannot verify that accurate focus was achieved.

Note that the audible feedback is only an indication that the focus plane adjustment, applied to the focus of the lens, matched the anticipated movement of the XF Camera. This tool is designed to learn the movements of the XF Camera over the course of a shoot, and therefore the more you repeat the same movement within a sequence of images, the greater the success. The initial capture from when the camera is turned on, may be imperfect in terms of AFr success, but the subsequent images will apply and fine tune the adjustment to your movement. It is suggested that you pair this audible feedback with the Zoom to Focus to visually confirm success.

Checking for correct focus

If you want to check quickly whether the subject is indeed in proper focus, you can setup the Preview image on the IQ Digital Back to help you out. The Preview image has an option to automatically zoom into the point of focus instead of showing the entire capture, making it much faster to review the focus accuracy.



Enabling AFR Zoom To Focus preview

This is done on the IQ Digital Back by choosing Menu > IQ Settings > Preview and then under AFr Zoom To Focus, selecting Always. The feature is set to Off by default.

Note that the AFr Zoom To Focus feature might zoom into an area that is slightly off the point where you locked focus. This is not a sign that the AFr mode has miscalculated the focus compensation, but it is always a good practice to judge the focus accuracy by viewing the main subject on the IQ Digital Back screen.

Supported lenses for AFr mode

Currently (as of XF Feature Update #4 SR1) the following Schneider Kreuznach Blue Ring lenses are supported for Autofocus & Recompose mode:

- 55mm LS f/2.8
- 80mm LS f/2.8
- 110mm LS f/2.8
- 120mm LS f/4.0 Macro
- 150mm LS f/2.8
- 150mm LS f/3.5

Assigning a custom button to toggle AFr mode On and Off

You will probably find it useful to be able to turn the AFr mode on and off quickly, depending on the subject to hand. This can be done by assigning a custom button to act as AFr mode toggle. Press the Rear Key and select UI Setup > Control Setup. Then select the button that you want to customize, and turn the Side Dial until you have selected AFr Mode.



Assigning AFR Mode button

Here we have assigned the Rear User Button as the toggle, but you can use any of these buttons:

- Shutter Release Button
- Secondary Shutter Release Button
- Front User Button
- Rear User Button
- External Shutter Release (B.O.B.)

Working with hyperfocal distance

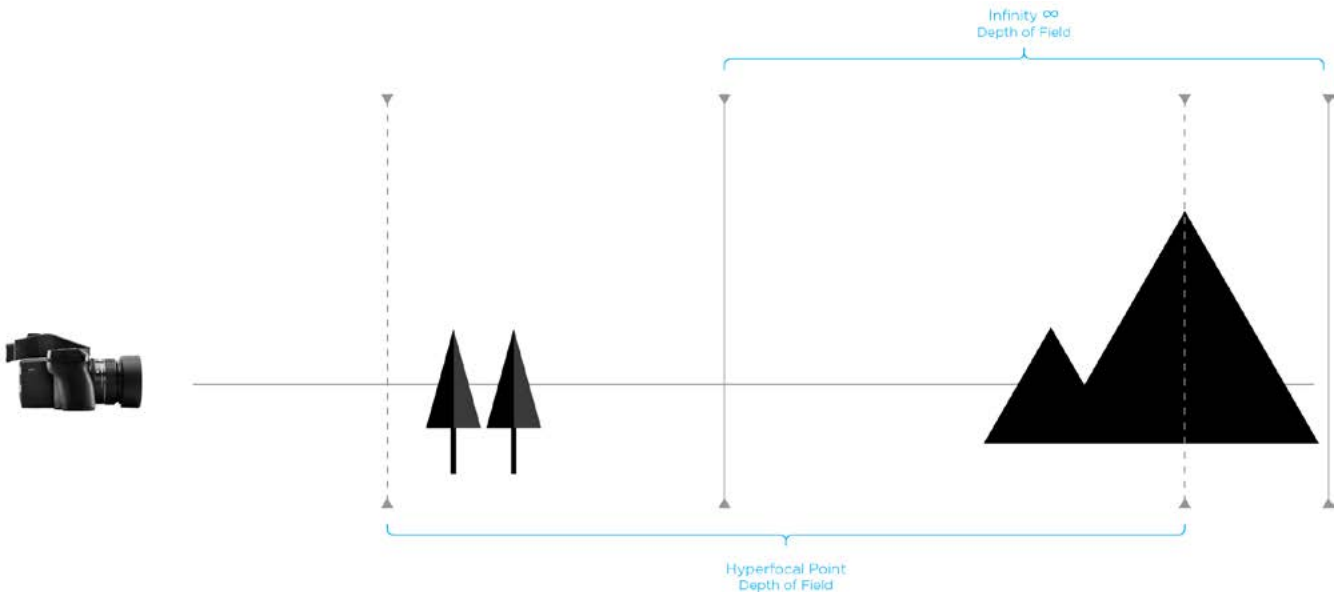

What is hyperfocal distance

An important element of landscape photography is ensuring that all of the key elements within your composition are sharp. This can often include foreground objects that are a matter of meters from your camera, as well as background elements that can be kilometres away. One way to ensure that the entire frame is in focus, 'acceptably sharp', is to ensure that the depth of field extends from the foreground to infinity. To do this, you need to focus at the 'hyperfocal distance'. For a given focal length and Aperture, there will be a distance where setting your point of focus will result in the entire scene being within the depth of field.

How you set it per tradition

For many photographers the best way to optimize the point of focus is visually. Try first focusing on the most distant object within your scene, then manually adjust the focusing point as close as possible while still retaining an acceptably sharp background.

Many use a rule of thumb, which states that you should focus roughly 1/3 of the way into your scene in order to achieve maximum sharpness throughout. While this is sometimes helpful, it is rarely optimal; the precise distance actually depends on many factors, including subject distance, Aperture and focal length.

Hyperfocal distance on the XF Camera System

The XF Camera System can store one specific focus distance for each lens. An obvious use of this functionality is to store the hyperfocal distance for the lens, at your preferred working Aperture. This focus distance can be recalled at your convenience.

On the XF Camera System this hyperfocal distance is represented by a “hyperfocal point” corresponding to the physical point or marker many photographers set on their lens to easily adjust focus to the hyperfocal distance. The XF hyperfocal point is measured in absolute “MCUs” (Motor Control Units). An internal scale, calibrated to the accuracy of the geared lens focus mechanism.

Saving an XF hyperfocal point:

Entering the XF Hyperfocal Point mode - via The XF Rear Key > Tools > Hyperfocal Point

Please NOTE that this always assumes that the lens is in AF mode.

Use dials and save an XF hyperfocal point:

In the HyperFocal Point Tool, now use the Front and Rear Dials to fine-tune your focus and depth of field for your scene. The Front Dial and the Rear Dial control the focus movements measured in “MCU” increments. The Front Dial: +/- MCU, the Rear Dial: +/-10 MCUs. The electronic control of the lens movements secures optimal positioning accuracy.

Please NOTE that it is important NOT to manually touch the focus ring of the lens in this mode, as this will interfere with the precision of the electronically controlled focus mechanism.

When you have reached an optimal hyperfocal point, it is stored by pressing the save icon of the Hyperfocal Point screen.

Use focus bracketing and save an XF hyperfocal point:

To assist an accurate setting of the Hyperfocal Point, a special focus bracketing function is available. It allows for capturing a sequence of 5 shots: the base shot focussed at your current Hyperfocal Point, complemented by four extra shots, focussed using the hyperfocus increment “Step” your selected MCUs, multiplied -2, -1, +1, +2.

It is strongly recommended to work tethered to Capure One, to accurately inspect each image for focus and depth of field, and secondly to get the Hyperfocal Point “call-out value” for each of the images in the capture sequence (In metadata).

When you select the image, which has the focus and the depth of field best covering your scene, you dial in the Hyperfocal Point call-out from Capture One in the Hyperfocal Point screen, and store the Hyperfocal Point by pressing the save icon of the Hyperfocal Point screen. You may continue the process with a finer increment, now working from your new best image as the base shot.

The captured images can also be inspected on an iPad, connected to an IQ2 or IQ3 XF Camera System via wifi and Capture Pilot, the Phase One wireless camera control software. The images can also be inspected on the XF rear screen. However, neither the iPad-monitor nor the XF rear screen can display the specific Hyperfocus Point “call-out value” of the images. These must be calculated manually.

Using the Hyperfocal Point

Once the Hyper Focal point is set, it is possible to select hyper focal mode as an AF mode (spot, average or hyperfocal). If Hyper Focal is selected, an activation of the AF button will move the lens to the stored value. Note that you can also assign a user button to activate the stored HyperFocal Point directly. This is done by selecting the Rear Key > UI Setup > Control Setup and then selecting the button you want to assign it to.

It is highly recommended to assign a different button than the shutter half-press to “Auto Focus” - this is done with the Rear Key > UI Setup > Control Setup.

The hyperfocal mode is not stored persistently. Once the XF is turned off it jumps back to the previous value.



HyperFocal Point Tool

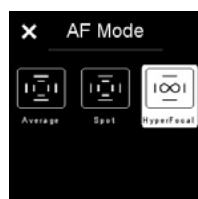
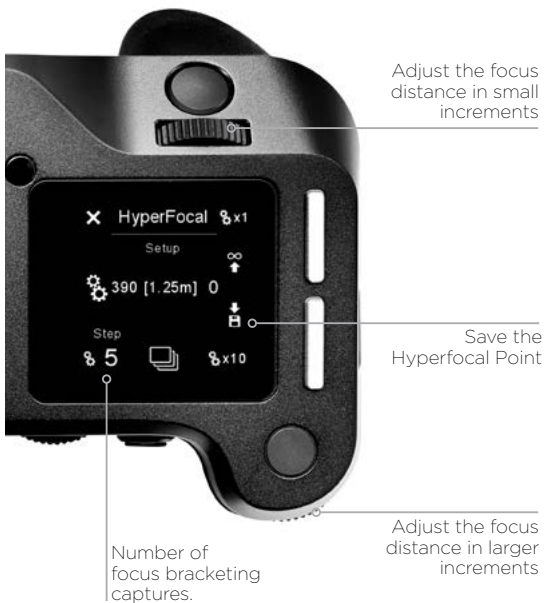
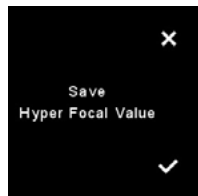

Select HyperFocal Point

XF Camera System Capture Modes

Capture Modes

The Phase One XF Camera Body has six drive modes; Single, Continuous, Vibration Delay, Bracketing, Delayed and Manual. Each mode is accessed from the drive mode screen after tapping the drive icon on the XF top screen, or from the duplicate XF screen on the IQ Digital Back after selecting XF Menu > Camera Controls...

Single capture

One image will be captured when fully pressing the shutter release button. Holding the button down will NOT result in additional captures. To make a subsequent capture, the shutter release button must be released then pressed again.

Continuous capture

The camera will capture images continuously to the fastest possible frame rate with the release button held down. Note frame rates are dependent on the IQ Digital Back model and file format selected.

Vibration Delay

The mirror is locked up automatically for reduced vibration and the shutter is released. In this mode, the XF Camera System uses data from its seismographic sensor to monitor the low vibration drive where a capture delay secures stability for the capture.

The maximum capture delay is set using a long press of the Vibration icon in Drive screen or by pressing the Rear Key on the XF top screen and from the menu: select Capture Setup > Vibration and then toggle the Rear Dial to the wanted delay.

The delay can be adjusted from 0.5 to 8 seconds or even set to Infinity. When the Vibration Delay time set in seconds is reached, the camera will always capture the shot regardless of the vibration level. With Infinite Vibration Delay, the XF Camera will wait until the vibration is low enough or you cancel the capture. Note that you can also initiate the capture manually at any time during the countdown by tapping on Capture Now on the XF top screen.

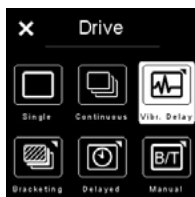

Vibration Delay mode



Vibration Delay options

Exposure Bracketing

This automatic function delivers a series of captures based around a metered exposure setting, irrespective of the Exposure mode selected. The XF Camera Body will automatically capture three frames in succession by default: one 1-stop under, one at the metered exposure and one 1-stop over. Bracketing steps can be selected up to 5.0 EV apart, with the option for selecting between 2-7 captures in total.

Press the Drive icon in the main screen to display the Drive modes, and then press and hold the Bracketing icon to reveal the Bracketing functions. From that dedicated screen, select the number of captures and the difference in EV between them using the rear and Side Dials.

Note to reduce vibration and to fine-tune the metered exposure setting respectively, the bracketing function can be used in conjunction with the Low Vibration mode , which can be turned on or off directly from the bracketing screen.



Exposure Bracketing



Bracketing with
Normal Drive



Bracketing with
Vibration Delay



Delayed capture mode

Delayed

In addition to the Vibration Delay feature, you also have the option of setting a specific delay timer manually. This is done by a long press of the delay icon on the drive screen, and then choosing the desired value in seconds with the Side Dial.



Manual (Bulb/Toggle)

Manual (Bulb/Toggle)

As a final capture mode, you can choose to do a fully manual exposure with the Bulb mode or Toggle mode. In the Bulb capture mode, you hold the shutter button down as long as you want the exposure to last. In Toggle mode, you initiate the exposure by pressing the shutter button once and then stop the exposure again with another press of the shutter button. The top touch screen will show the length of the capture while using this mode. Note that after you have stopped the capture, a black frame calibration will take place automatically, and the top touch screen will display a timer countdown while the black frame is recorded.

You can choose between Bulb and Toggle mode by either turning the dial assigned to shutter speed, or by a long press on the Manual icon in the drive screen popup menu. Instead of displaying the shutter time, the touch screen will now show either B or T.

Please note that when Manual drive mode is selected, all remote capture functions are treated as Toggle, even if Bulb is selected. So if the capture button is activated from Capture One, the first tap opens the shutter, and the second tap closes the shutter again.

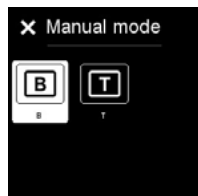

Choosing between Bulb and Toggle

XF Camera System Exposure Modes

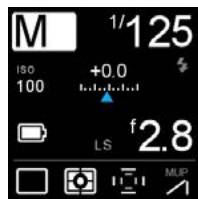

Exposure Mode

Changing the Exposure Mode

Exposure is controlled manually with the XF delivered set to M (Manual) by default, with the Shutter Speed set by the Front Dial, and Aperture values selected by the Side Dial. ISO settings are selected by the Rear Dial. However there are two additional semi Auto exposure modes available: Av (Aperture Priority), Tv (Shutter Priority), and a full Auto P (Program) option.

In the standard Classic screen layout, the Exposure Mode can be changed by tapping the icon on the top touch screen, followed by a selection of the preferred mode or followed by toggling the rear or Side Dial.

In the semi-Auto modes, where the Aperture or Shutter Speed is selected automatically by the camera, the redundant dials may be customized to automatically select the Exposure Compensation function instead. See Exposure Compensation setting for more details.

ISO Setting

ISO sensitivity can be set either by scrolling the Rear Dial on the XF Camera Body or by selecting ISO with the top right key of the IQ Digital Back. Settings are automatically transferred between the IQ Digital Back and the XF Camera Body. The ISO range available is dependent on the IQ Digital Back model attached to the system.



Auto ISO Setting

Auto ISO Setting

An auto ISO option is useful in rapidly changing lighting conditions. On the XF Camera Body, the function is accessed by pressing the ISO icon on the top screen, or from the XF Camera Body menu on the IQ Digital Back. Note there's no access from the back's ISO shortcut button or upper right key. The Auto ISO screen displays minimum and maximum ISO limits to set a working range, for example, to limit noise. To set the Function to Auto, select OFF > Auto. To set the limits, scroll through the range using the Rear and Side Dials. No confirmation is required, as the settings are saved automatically. Return to the main screen by the touch the cross (X) mark or half-press the shutter release button.



OneShot AE

OneShot AE Exposure Mode

The OneShot AE mode is a very useful feature when you work in Manual exposure mode and quickly need to switch the XF Camera to automatic exposure to get a shot. In essence, OneShot AE will turn on automatic exposure temporarily for the next capture only by pressing an assigned key. Once the shot is taken, the camera will revert to the exposure settings that you had chosen beforehand.

First, you need to assign a button to use for OneShot AE. This is done by pressing the rear key and selecting UI Setup > Control Setup > and choosing the desired button. Then turn the Rear Dial until you have selected OneShot AE.



OneShot AE options

Next, setup whether Aperture, Shutter Time and/or ISO should be automatically controlled by OneShot AE. Press the rear key and select Capture Setup > Auto Exposure > OneShot AE. Then select Aperture, Shutter Time or ISO and turn them On or Off with the Rear Dial. Please note that you can choose any combination and allow the camera to change all three values automatically or just one to obtain the right exposure. By default, the XF Camera is set to only change the Shutter Time, but you can, for instance, change the OneShot AE feature to only change the ISO value to obtain the proper exposure.

With everything setup as needed, just press the assigned button to activate the OneShot AE for the next shot.

Exposure Compensation



AF Priority	Focus
Assist Light	Off
Shutter	LS Priority
ES 50/60Hz Filter	Off
EV Steps	1/3 Step

Exposure Compensation Steps

Using Exposure Compensation

The Exposure Compensation function is available primarily for the semi-auto and auto exposure modes (Av, Tv, and P), but it can also be used in manual exposure mode. Compensation can be set from -5 to +5 EV in either 1/3, 1/2 or 1 EV increments. By default, exposure compensation is applied in 1/3 EV increments. (To change this to 1/2, or 1 EV increments, press the top rear key and then select Capture Setup > EV Steps > 1/3, 1/2 or 1. Note that this setting is global.)

The EV value applied is displayed on the top screen and in the viewfinder display and remains fixed, regardless of the number of captures. To remove any exposure compensation applied, access the function again and set the value to 0 (zero).

Exposure Compensation can be selected from the camera's top-screen by touch or the Front Key and applied by scrolling through the value (EV value) using the rear or Side Dials.

Exposure Compensation Quick Set in Auto

In the semi-auto modes, where either the Aperture or Shutter Speed is set automatically by the camera, the redundant dial may be reconfigured to modal operation, for setting the Exposure Compensation function for example. The change in function is applied automatically when selecting the semi-auto or auto exposure modes. Access the XF menu from the top screen (or IQ screen) and select UI Setup > Control Setup > Front / Side Dial > In Auto > ExpComp.

The Rear dial, by default, alters the ISO sensitivity, but if this function is subsequently set to Auto (by touching the ISO icon, and selecting Off > Auto), the dial can be reconfigured in the same way as the others to adjust Exposure Compensation in the Auto ISO mode.

Long Exposure

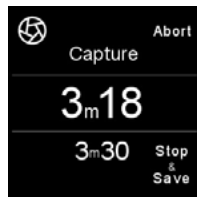

3.30 min exposure at 3.18 min

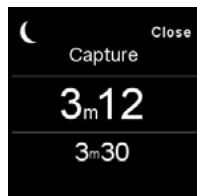

Black frame capture at 3.12 min

The IQ Digital Back model determines the long exposure capabilities of the system (please refer to the IQ technical specifications for a particular model), however, the basic operation remains the same between them and all relevant settings are synchronized between the IQ Digital Back and XF Camera Body. The IQ series models are all capable of long exposures up to 60 minutes in duration, selected directly from the Front Dial of the XF. No special Exposure mode is required when using the Phase One XF, however Manual exposure mode is recommended.

Select the Aperture using the Side Dial. Compose using the viewfinder or Live View, focus and then trigger the shutter release. The shutter remains open for the allotted time and the top screen of the XF will show the elapsed time (in secs). Shutter speeds longer than 1.0 second automatically change the leaf shutter option (if available) over to the camera's integrated focal plane shutter.

Noise Reduction (Dark Frame Subtraction)

In order to minimize noise, an additional dark frame is captured for the same duration as the capture and subtracted from the original exposure. This is fully automatic, and there is no need for the user to intervene. After the elapsed exposure time, the screen displays a count-down in seconds during the dark frame subtraction, and the icon in the top-left of the screen changes from an iris to a crescent moon to denote the operation. The Stop and Save option ends the exposure and automatically starts the dark frame capture. If the user selects Abort, the image is not saved. When the noise reduction (dark frame) process is finished, the camera is ready to capture another image.

Electronic Shutter (ES)



When using the IQ3 100MP Trichromatic, IQ3 100MP or IQ3 100MP Acromatic Digital Back, it is possible to capture the images using the Electronic Shutter. It not only provides advantages for a number of capture scenarios but it extends the control and workflow possibilities for Live View, black frame calibration integration and technical camera applications.

The Electronic Shutter has several advantages. Since there are no vibrations from a mechanical shutter, it is easier to capture the finest details and fully enjoy the high resolution of the IQ3 100MP Trichromatic, IQ3 100MP or IQ3 100MP Acromatic Digital Back. Another advantage of using the Electronic Shutter is that there is no mechanical wear when shooting a very large number of photos. Additionally, you can capture an image completely silently.

However, it does take a noticeably longer time to read the entire image from the sensor when using the Electronic Shutter rather than the mechanical shutter. The full read-out time is typically up to one and a half second, and as a consequence, it will only support flash synchronization of 1.6 seconds. However, the Electronic Shutter is a great choice when doing studio work or copy stand photography using continuous light.

The Electronic Shutter can also be used for landscape images, where there are only small local movements, for example leaves, trees or waves. This is because the movements are captured instantly at the specific location of the small moving subject. Larger subjects, like a moving car or running persons will be distorted in the image. As a consequence, the Electronic Shutter is best suited for tripod use.

Please note: Bulb and Toggle function on XF will not work in ES mode.

Enabling the Electronic Shutter

The Electronic Shutter can be enabled via the XF Camera Menu on the top touch screen by selecting Capture Setup > Shutter > ES only. You can also enable it on the IQ Digital Back by selecting XF Menu > Capture Setup > Shutter Mode > ES Only.

If you are using the the IQ3 100MP Trichromatic, IQ3 100MP or IQ3 100MP Acromatic Digital Back without the XF Camera, you can enable the Electronic Shutter by selecting Menu > Camera > Electronic Shutter > On.

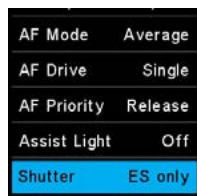

Enabling the Electronic Shutter from the Top Touch Screen

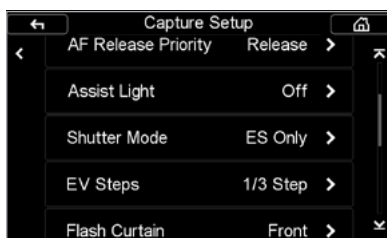

Enabling the Electronic Shutter from the XF Menu.

Using Electronic Shutter (ES) without the XF Camera Body

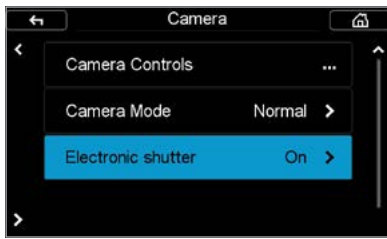

Enabling the Electronic Shutter on the IQ3 Digital Back



When using the Electronic Shutter on the IQ3 100MP Trichromatic, IQ3 100MP or IQ3 100MP Acromatic Digital Back with, for instance, a Technical Camera instead of the XF Camera Body, you control the shutter speed and other exposure settings via the Camera Controls on the IQ3 touch screen. You first need to make sure that the Electronic Shutter is enabled on the Digital Back by selecting Menu > Camera > Electronic shutter > On. You then activate the Camera Controls by either pressing the ES icon on the touch screen, or by pressing the bottom right button.

Capturing with a remote release is also possible. Please ask your Phase One partner for an IQ3 100MP Electronic Shutter (ES) Cable Release Adaptor (P/N: 73174).

Setting the Exposure

Using the Camera Controls is straightforward - simply touch the shutter speed or ISO values to change them. Note that since the aperture is set on the technical camera lens, you will need to enter the used aperture value in order for it to be written correctly into the metadata of the image. You set the white balance by tapping the White Balance icon. You also have the option of enabling Live View by tapping the icon in Camera Controls. Once you are all set, just press the shutter button to start the exposure.

Self Timer Delay

It is possible to specify a delay from when the shutter button on the screen is pressed until the image capture begins. Just tap the Self Timer Delay icon and choose the desired value. The delay is then displayed on the shutter button. Once you press the shutter button, a countdown will appear until the image capture begins.

Enable Antiflickering

When using the Electronic Shutter, there are certain shutter speed values that do not work well with light sources flickering at either 50Hz or 60Hz. The IQ3 can determine which shutter speeds are problematic, and automatically choose the nearest value that works with the current frequency. You can enable this feature by tapping the Antiflickering icon. A blue dot will be shown when it is enabled.

Please note that Antiflickering will not be in effect if you are using P or Av mode on the XF Camera.

Recording a Black Frame Calibration

Recording a black frame calibration cannot be done fully automatically when the IQ Digital Back is mounted on a technical camera, since the IQ has no way of determining whether light is hitting the sensor or not. So when a black frame calibration is needed, the IQ will prompt you to put on a lens cap during the black frame calibration capture.

Black Frame Calibration options

You can choose between three different settings for the black frame calibration. This is done by tapping on the Black Frame Calibration icon and then cycling through the three options. You can choose between:

1. **Normal.** The IQ3 initiates a black frame calibration whenever needed. This will happen when you change the shutter speed or ISO, or a certain amount of time has passed since the last capture. This is the default setting.
2. **Always.** The IQ3 will always make a black frame calibration between each capture. This option is shown with a blue dot on the icon.
3. **Suppress.** The IQ3 will not make a new black frame calibration if the Digital Back determines that a change to the exposure is minimal and will not impact the image quality notably. This option is shown with a red cross over the icon.

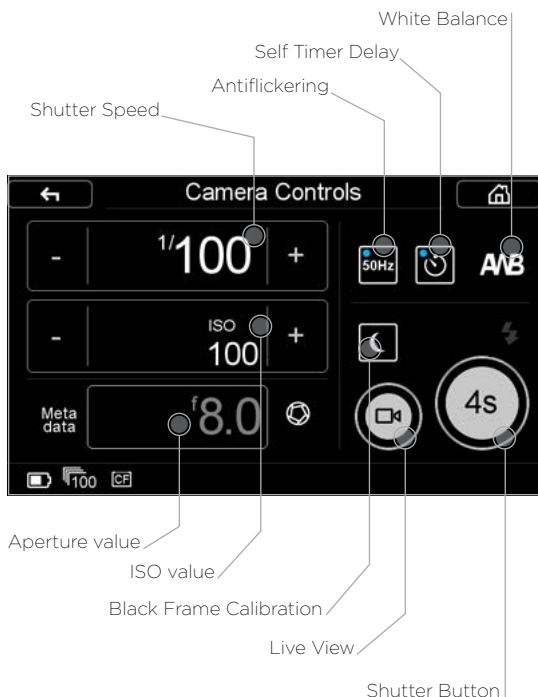

Live View



Zoom slider

Exposure settings overlay

Live View on the IQ Digital Back

All IQ Digital Backs are capable of displaying a Live View on the rear touch screen. It is a very effective method for capturing still subjects. Using a tripod is recommended to prevent blurred images. The preview image is displayed at the selected Aperture, and the Aperture value may be changed by the user during previewing to observe the effect on the depth of field. Exposure is not simulated in order to make the screen easier to see, and so the exposure compensation function is disabled.

Note, due to the faster refresh rates, the quality of the Live View image displayed on an IQ Digital Back with a CMOS sensor is superior to that from a CCD.

All IQ Digital Backs support tethered Live View using FireWire 800 or USB 3.0, except for the IQ3 100MP and 50MP Digital Backs which offer Live View with USB 3.0 only.

The IQ3 100MP Trichromatic, IQ3 100MP or IQ3 100MP Acromatic Digital Backs have an additional live view output option to an external monitor or screen via HDMI. The HDMI output connector is located behind the CF-port door on the right hand side of the IQ3 100MP versions. (HDMI output is described on next page).

Live View on the IQ Touch Screen

From the IQ Home screen, touch the context menu icon in the lower right corner of the display. The contextual menu pop-up is displayed. Touch the Movie-camera icon to initiate Live View. The XF Camera Body opens the shutter and a live preview (Live view image) is displayed on the rear screen. You can access the camera controls from live view by tapping on the exposure settings overlay or initiate a capture simply by tapping on the shutter button on the screen. Please note that the overlay fades out when the screen hasn't been touched for a few seconds. Just touch it again to access the controls.

Focus in Live View using the IQ Touch Screen

AF is not available during Live View. Select Manual Focus (MF) from the Lens Selector Ring and focus on the subject using the Live View image.

Touch the screen and the display will enter Full Screen mode. The live preview can be zoomed to check focus. The Zoom slider appears when touching the left side of the screen in full screen view. To zoom in an image in full screen, slide your fingertip upward on the Zoom slider. To zoom back out, slide your fingertip down on the slider. To make a quick zoom to 100%, double-tap on the area of interest. To examine other areas of the preview, the image may be dragged with your fingertip. Double-tap the screen to return the full screen display. To exit live view, press the upper left key of the IQ Digital Back.

Image Capture in Live View

Follow the steps outlined above to enable Live View and confirm focus. Select the Low Vibration mode or enable the Single (or Continuous) Drive modes and use a cable release to prevent vibration in the images.

Once you are ready to capture press the shutter release button on either the cable release or on the camera.

Capturing from within Live View will have a little longer latency than normal, since the camera have to step out of Live View, and close the shutter before an actual capture can take place. Once the image is captured the camera will show the image for a short while, and then step back into Live View. The display time can be setup in Menu>Preview in LiveView.



The Micro HDMI socket is hidden behind the CF Door

Live View output to HDMI from the IQ3 Digital Back

Using the Supplied Micro HDMI adapter, connect your monitor to the HDMI output located behind the CF-card cover on the IQ3 100MP Trichromatic, IQ3 100MP or IQ3 100MP Acromatic Digital Back.

NOTE: The HDMI adapter cable will adapt to any standard HDMI male to male extension cable. Because of the limited space around the socket we choose to include this cable - should you want to replace with another standard Micro HDMI cable, then please note that not all connectors will fit due to the limited space surrounding the connector.



Select HDMI in the Context Menu

From the Home screen, or from Thumbnail or Tools view, touch the context menu icon in the lower right corner of the display. The context menu pop-up is displayed. Touch the HDMI icon to initiate Live View on the external HDMI monitor. The XF Camera Body opens the shutter and a live preview will be transmitted to the external screen.

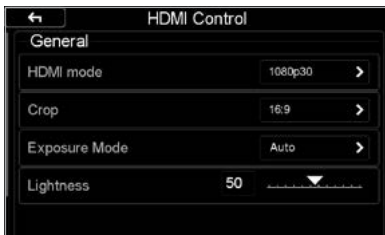

HDMI settings on the IQ Touch Screen

HDMI Control Panel

While HDMI is transmitted to the external screen, the IQ touch screen will present the HDMI Control panel.

Here you can set the HDMI output mode, Crop (and aspect ratio), the Exposure Mode and in Auto Exposure Mode you can also adjust the lightness via a lightness slider.

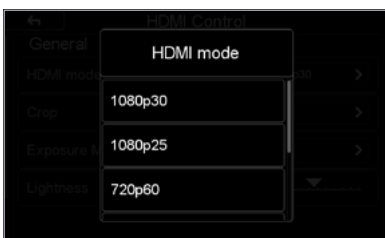

Select HDMI output mode

HDMI mode

The IQ3 100MP Trichromatic, IQ3 100MP or IQ3 100MP Acromatic Digital Back can output in four HDMI modes:

1. 1080p30
2. 1080p25
3. 720p60
4. 720p50

Select the HDMI output depending on what resolution your monitor supports and which electrical frequency is used in your area (50Hz/60Hz).

For instance selecting 1080p30 or 720p60 in the US will ensure that electric lighting frequency (60Hz) will not interfere with the framerate, which can result in flickering.

Whereas in Europe you should select 1080p25 or 720p50 which is compatible with electricity frequency in Europe (50 Hz).

Crop

Crop can be set to either 16:9, Full Sensor 4:3 or Zoom 100%.

In 16:9 the top and the bottom area of the Sensor will be masked out, whereas in Full Sensor 4:3 the full view of the sensor is shown. and if on a 16:9 monitor, the 4:3 format will be shown with two black areas in the left and right side of the screen. Zoom 100% will zoom to 100% resolutions view at the center of the sensor.



Manual Exposure mode

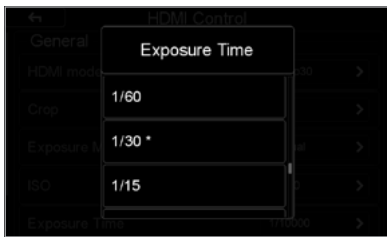

Exposure Time selector

Auto Exposure Mode

The default setting for HDMI Live View is Auto Exposure mode. This mode ensures that your Live View Image get displayed with a suitable gain factor, regardless of how much light you have in the scene. In addition, this mode provides a lightness slider for adjusting the lightness of the output image. The Auto Exposure Mode uses sensors ISO and exposure time to adjust the image on screen. Should you want to control these settings manually then you can switch the Exposure Mode to Manual.

Manual Exposure Mode

In Manual Exposure Mode, you will have the option to control the ISO and the exposure time. As with stills photography, a high ISO setting will result in a more noisy image. Exposure time menu will show a list of possible exposure times, depending on which HDMI mode you have selected. To avoid any dropped frames or transitions, for instance when recording the signal, please limit your exposure time selections to the ones marked with an asterisk (*). These are the native exposure times that match the frame rate of the selected live view mode.

Please also note that to avoid flickering, you should setup Antiflickering to the correct voltage frequency depending on where in the world you are. This is done in: Menu > IQ Settings > Antiflickering.

XF Custom Presets and System Backup

XF Camera Body Custom Presets

Custom Presets

Three Custom Presets can be set on the XF Camera Body. This feature allows you to save and reuse combinations of settings you have made to the system to suit your preferences and workflow. Custom Presets also minimize inadvertent use of settings, where the same camera may be adopted for very different assignments or commissions throughout the day. All the current settings can be saved in a Custom Preset.

Save Custom Presets

Set up the camera with the various settings required, then press the Rear Key on the XF top screen and from the menu select Save Setup > Custom 1 > Save Setup > Yes / No. Two further groups of settings can be stored (to Custom 2 and Custom 3).

If you change a setting while using the camera in one of the Custom modes and want that set updated, simply access the camera menu and select Save Setup, remembering to save it to the relevant Custom set.

Changing between Custom Presets

Custom presets are intended to provide a rapid change between groups of settings and features. Press the Rear Key on the XF top screen and from the menu select Load Setup > Custom 1, 2 or 3.> Load Custom Settings > Yes / No. Selecting Yes instantly enables the group of settings. Settings may be continued to be changed afterwards as normal, and to return to the initial group of settings, simply repeat the procedure described above.



Custom Settings

Save Custom Setup to CF Card

In addition to saving custom setups in the XF Camera, you can also save them to the CF card as a backup file. This is done from the IQ touch screen. Select Menu > XF Menu > Custom Setup > Save To CF. Then choose the Custom Setup you want to save, and press the green check mark to accept. The backup file is saved at the root of the CF card and called XFSsystem.set, in case you want to copy it to your computer.



Save Custom Setup to CF card

Load Custom Setup from CF Card

Once you have saved a Custom Setup to the CF Card, you can load it back into the XF Camera. This is done from the IQ touch screen. Select Menu > XF Menu > Custom Setup > Load From CF. First, choose the current Custom Setup on the XF Camera that you want to replace. Next, choose which of the saved Custom Setups on the CF card you wish to load. Select the one you want, then press the green check mark to load it.



Choose the Custom Setup to load from CF card

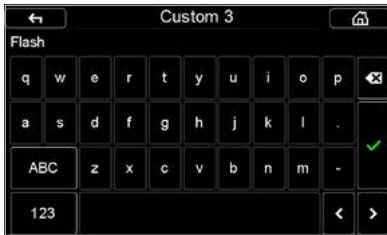

Using the touch keyboard to rename the Custom Setup

Rename Custom Setup

In order to better recognize each of your Custom Setups, you can rename them to something more descriptive, like 'Landscape' or 'Studio'. This is done from the IQ touch screen with the built-in keyboard. Select Menu > XF Menu > Custom Setup > Rename. Then choose the Custom Setup you want to rename, and enter the name on the touch keyboard. Once you are done, press the green check mark to accept the change.



Restore the Custom Presets to Default

Restore to Default

To return the camera to the default settings, access the camera menu and select Load Setup > Restore To default...

Note the group of settings registered with the Custom Presets will be not be cleared using this option.

Save and Load System Setup

You can easily make a backup of the entire System Setup to the CF card. This backup will include all of your settings on the XF Camera, your Custom Setups, as well as all of the settings on the IQ back.

This feature makes it easy to quickly load your preferred settings if you frequently share the XF Camera System with other photographers. It is also a convenient way to quickly be able to reuse all of your settings if you often rent an XF Camera System.

The backup file is called XFSYSTEM.set and is stored at the root of the CF card. From there, it can be copied to your computer for further backup or sharing. Note that the file will get erased if you format the CF card.

Save System Setup to CF Card

The backup of the System Setup is done from the IQ back. Select Menu > System Setup > Save To CF, and press the green check mark to accept. The system will now confirm that the System Setup of both the IQ back and XF Camera has been saved to the CF card. If the XF Camera Body is not attached to the back, only the IQ settings will be stored.



System Setup has been saved to the CF card

Load System Setup from CF Card

To load your saved System Setup, select Menu > System Setup > Load from CF, and press the green check mark to accept. You will need to turn the system off and back on before all the changes are applied. If there is no valid backup file present on the CF card, you will get a warning..

NOTE:

Settings like Focus Trim and HyperFocal focus values are stored as part of the System Setup backup and will be applied if you save and load the System Setup on the same XF Camera Body. However, they will not be applied if you load the System Setup onto a different XF Camera. The reason for this is that Focus Trim and HyperFocal focus values have to be setup individually for each camera system in order to work correctly.

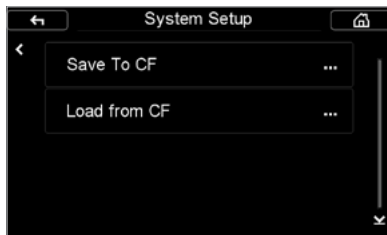

Loading the System Setup from a CF card

Restore to Default

You can easily restore all of the settings to the default values. This is done from the IQ back. Select Menu > System Setup > Restore to Default. As a convenient feature, you have the option to choose whether the current copyright information, splash and background screens, custom white balance values and WiFi settings should be reset or kept during the restore. Select only those you want to reset to default values, and press the green check mark to accept. This feature makes sure that you do not have to reenter some common settings each time you need to restore the system to default settings.

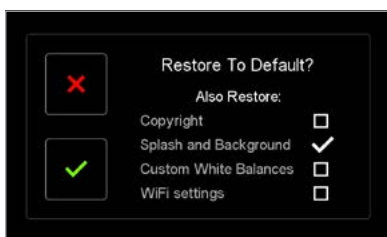

You can choose to keep certain settings during a Restore to Default

Flash Photography



The XF Camera has a range of powerful flash photography features. First and foremost, the functionality of the Profoto Air system is built directly into the camera, letting you work easily and efficiently with any Profoto Air flash setup.

With the integrated Profoto Air Tool, you can control up to six groups of Profoto lights wirelessly directly from the XF Camera display and fire the different flash groups. The XF Camera also supports TTL and Profoto AirTTL flash metering, making it easy to get accurate exposures under changing lighting conditions when working on location.

You can even trigger a capture remotely with a Profoto Air Remote, or review flash duration, output power and flash sync timing after each capture with the Flash Analysis Tool. You also have the option to trim the flash sync timing directly from the camera to achieve perfectly timed flash results.

All of these powerful flash photography tools are explained in detail in this section.

The XF Camera can also work with a range of other flash solutions in manual mode, and the camera offers flash syncing up to an unprecedented 1/1600th of a second with the majority of Schneider Kreuznach LS (Leaf Shutter) lenses.

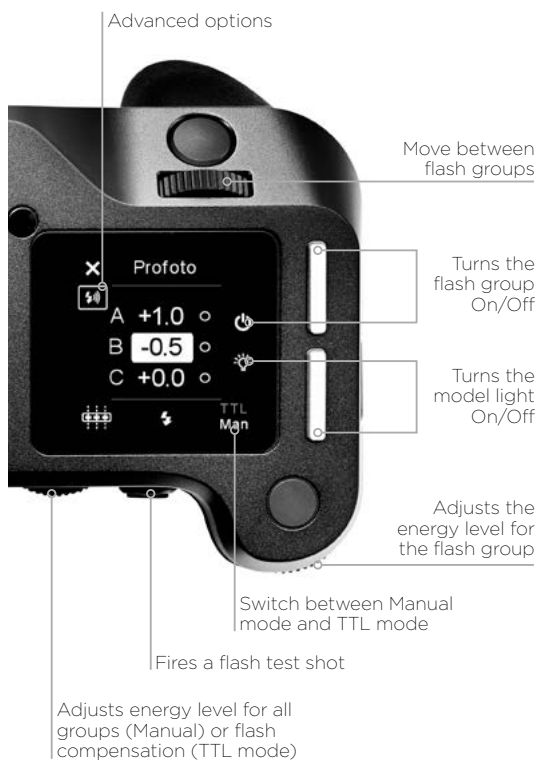

Profoto Remote Tool

The XF Camera System can wirelessly control any Profoto Air-enabled flash system through the Profoto Remote Tool. The tool is designed to work in almost the same way as a Profoto Air Remote unit, in order for you to use it as easily as possible with a Profoto Air system. You get to the Profoto Remote Tool by swiping on the top touch screen.



Enabling Profoto Flash

Enabling Profoto Air Sync and Air Remote

Profoto Air Sync and Air Remote is not enabled by default. To set up the wireless syncing and controlling function, access the camera menu and select Capture Setup > Profoto > Profoto Flash > On. The wireless channels for both Transmit and Receive can be selected in the same menu. Select between channels 1 to 8. Channel selection should correspond to the channel selected on the Profoto flash system or Profoto Air Sync transceiver in use. You also have two options to turn Profoto PreFlash On or Off, and set the AirTTL mode.

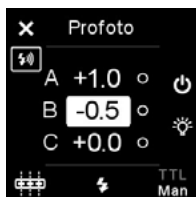

Changing the Energy level with Profoto Remote Tool

Using the Profoto Remote Tool

You select and move through the different Flash Groups A, B and C with the Front Dial, and then change the selected energy level, indicated in stop increments, with the Side Dial. Note that any changes you make to the energy levels with the Profoto Remote Tool are done as incremental values that add or subtract from the current energy levels on the flash generator. So if the energy level on the flash generator is at 6.0 and you dial in a +0.5 value on the Profoto Remote Tool, the energy level on the flash generator will be changed to 6.5. Once the flash has fired, the energy value on the Profoto Remote Tool will be reset to 0.0, but the energy level on the flash generator will stay at 6.5 until changed again. Note that the Profoto Remote Tool cannot be set up to show what the current energy level is on the flash generators. The rear button on the XF Camera is used to test fire the flash system.

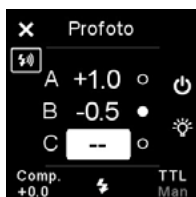

Controlling Flash Group and Model Light

Turning a Flash Group On/Off

The top front button is used to turn the selected Flash Group on and off. If a Group is off, two dashes are shown instead of an energy value. If you keep the top front button pressed for a few seconds, then all Flash Groups will be switched on or off.

Turning the Model Light On/Off

Use the top rear button to turn the Model Light on and off for the selected Flash Group. A white dot will indicate that the Model Light is on. If you keep the top rear button pressed for a few seconds, you can switch the Model Light On or Off for all Flash Groups at the same time.

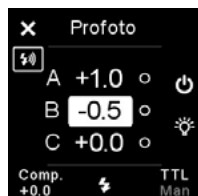

TTL mode enables the Flash Compensation Value

Changing between Manual mode and TTL mode

You can change between shooting in Manual mode or TTL mode by turning the until you reach the option at the right bottom corner of the Profoto Remote Tool. Then turn the Side Dial to switch.

Note that when Manual mode is selected, the Rear Dial will change the energy level for all Flash Groups at the same time regardless of which group is selected. If TTL mode is selected, the Rear Dial will instead control the Flash Compensation Value.

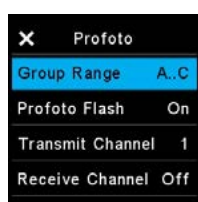

Advanced Settings menu for Profoto Tool

Changing the number of Flash Groups

You are able to control three Flash Groups with the Profoto Remote Tool by default, but you can change this range down to one and up to six Flash Groups. You do this by tapping the Advanced Settings icon which is just below the Close Tool icon in the upper left corner. You then change the Group Range from A..C to A..F with the Side Dial if you want all six Flash Groups enabled. Note that the Advanced Setting menu also lets you change Transit and Receive channels as well as Profoto PreFlash and AirTTL mode.



Changing Transmit and Receive channels

Triggering a Capture with the Profoto Remote

You can use a Profoto Remote unit to trigger a capture with the XF Camera remotely as well as firing the flash system during the capture. For this to work correctly, you need set the Transmit Channel and the Receive Channel to two different channels and make sure that the Profoto Remote controller matches the Receive Channel and the Profoto Air flash system matches the Transmit Channel.

To setup the Transmit Channel and the Receive Channel, press the Rear Key and select Capture Setup > Profoto. Then select either the Transmit Channel or the Receive Channel and turn the Side Dial to select the desired channels.



Disabling the Receive Channel



Disabling the Transmit Channel

Note that you can set both the Transmit Channel and the Receive Channel to Off. If you set the Transmit Channel to Off, the XF Camera will not trigger a flash system, and you can use the Profoto Remote as just an external wireless trigger when you do not need a flash. Likewise, you can set the Receive Channel to Off if you do not want to ability to trigger a capture remotely, but still need the XF Camera to trigger the Profoto flash system.

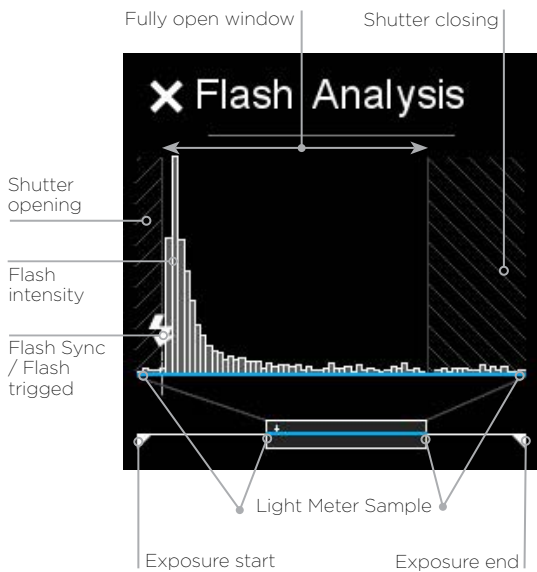

Flash Analysis Tool

The Flash Analysis Tool is used to visualize the flash output power, flash duration and timing within the exposure where a flash is fired. The Flash Analysis tool can be reviewed when accessing the tool from the Icon on the Top Screen or through the swipe menu.

At the bottom of the Flash Analysis Tool, there is an exposure line that represents the time in which the sensor is exposed to light. The two white triangles are indicators for the start and the end of the exposure.

On top of the exposure line there is a blue rectangle overlay, called the Light Meter Sample. This is a magnified part of the full exposure which visualizes the time range in which the flash has been fired.

Within the magnified part, there are one or two striped segments. These represent the time in which the shutter is partially or fully closed. The black segment of the graph in the middle represents the time in which the sensor is fully exposed to light.

In the lower left corner of the graph the flash sync icon indicates when the flash is fired. Once a flash is fired, you will see a series of vertical white bars that indicate the strength, duration and fall off the flash light.

Note that time interval of the Light Meter Sample is always equal to approximately 7 ms. — 1/125th of a second — and start right after the flash is triggered. So, when a flash is fired within this time interval, you will see the beginning of the flash output coincides with the flash sync icon.

Rear Curtain sync and Trim

Note that you have the option of choosing between front and rear curtain sync for your flash system from the XF Camera. This is done by accessing the camera menu and selecting Capture Setup > Flash Curtain > Front/Rear.

In addition, you can trim the flash sync timing directly from the XF Camera to achieve perfect results. If you are using rear flash sync, you can trim the sync timing to fit your specific photographic needs, and this feature is particularly useful in combination with the Flash Analysis Tool.

To find this setting, access the XF Camera menu and select Capture Setup > Rear Curtain Trim. By default, this trim is set to a value of -5. A value of 0, when using rear curtain sync, indicates that the flash fires at the exact moment the shutter closes. Moving it to a positive value will fire the flash after the shutter closes.

This is applicable only when using Focal Plane Shutter as the shutter in this mode takes some time to close. Moving the value to a negative value offsets the flash sync to a point closer to the start of the exposure.



Flash Curtain Rear

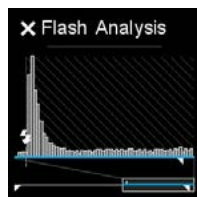

Flash Analysis Tool with Curtain set to Rear

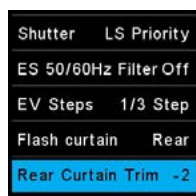

Rear Curtain Trim

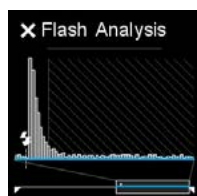

Flash Analysis Tool with Rear Curtain Trim

Shutter Mechanisms and Flash Synchronization range

There is a big difference in the way that the Focal Plane Shutter, the Leaf Shutter and the Electronic Shutter works when you shooting with a flash system. Because of this, it is valuable to know how the different shutters work to fully take advantage of the Flash Analysis Tool.

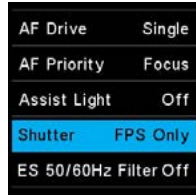

Focal Plane Shutter (FPS Only)

Focal Plane Shutter (FPS)

The focal plane shutter works by having two curtains moving vertically in front of the sensor to control the exposure time. First, the front curtain opens so the light can start to reach the sensor, and after the appropriate delay, the rear curtain follows and closes the exposure. It takes several milliseconds for the curtains to move from open to closed. This is important to know if you are using a fast shutter speed, because then one or both curtains will cover a part of the sensor, and the fired flash will only light up a row of all the pixels. Because of this, the flash sync speed with the focal plane shutter cannot be faster than 1/125 second. Note that the Flash Analysis Tool will show a hatched pattern to indicate when the shutter is not fully open.



Leaf Shutter (LS Priority)

Leaf Shutter (LS)

The leaf shutter built into the Schneider Kreuznach Leaf Shutter lenses works in a different way. Instead of curtains moving vertically, the shutter consists of a series of blades, that opens and closes — not unlike a lens aperture — to control the exposure. In effect, they form a hole that gradually becomes smaller until it is fully closed. It works a lot faster than the focal plane shutter and has the advantage that all pixels gradually get less and less light until the exposure ends. Because of this, the flash sync speed with a leaf shutter can be as fast as 1/1600 seconds. Note that when the XF Camera is using the leaf shutter as the second curtain, it automatically uses an electronic first curtain. The electronic first curtain works almost instant, so when you are inspecting the Flash Analysis Tool, you will note that the shutter is almost fully open during the entire exposure time.

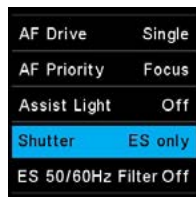

Electronic Shutter (ES Only)

Electronic Shutter (ES)

When you use the Electronic Shutter feature on the IQ3 100MP, both the first and second curtains are fully electronically and controlled by the sensor. No mechanical shutter is used. Since the sensor cannot open and close all the pixels simultaneously, it instead uses a rolling shutter mechanism where it reads lines of pixels slowly across the sensor. It can take more than a second to read out the entire sensor, so the shutter time must be long in order for the flash light to hit all pixels on the sensor. As a consequence, the electronic shutter will only support flash sync of around 1.6 seconds, but note that it will work perfectly when using continuous light for copy stand photography.



Flash Readiness Icon

Synchronization readiness is indicated on the top screen with a small flash icon located beneath the shutter speed setting. If a flash icon is not visible, the shutter speed setting is outside range of the attached lens or manually selected shutter.

Wired Flash

Wired manual flash is possible through the flash sync port on the XF Prism Viewfinder or IQ Digital Back, with appropriate cable. Manual flash is also possible through the hot shoe, located on top of the prism viewfinder. Slave units and wireless transmitters can also be connected. Please refer to their respective user manuals for more details.

Note Phase One A/S cannot accept responsibility for accidents or damage occurring as a result of using third-party devices in conjunction with Phase One equipment.

XF Camera System Lenses

Focal Plane and Leaf Shutter Lenses

The Phase One XF offers a dual shutter option for the utmost in exposure versatility with flash and ambient light.

Phase One FPS (Focal Plane Shutter) lenses

The XF Camera Body has a built in focal plane shutter (FPS) for use with Phase One lenses and offers a range of Shutter Speeds from 1/4000th second to 1 hour (determined by the IQ Digital Back model used), however flash sync is limited to a maximum of 1/125th of a second Shutter Speed.

Schneider Kreuznach LS (Leaf Shutter) lenses

Schneider Kreuznach lenses have a built-in leaf shutter (LS). When used in combination with the Phase One XF Camera Body and IQ Digital Back, the leaf shutters have the capability to synchronize with flash systems up to an unprecedented 1/1600th of a second Shutter Speed.



If using LS lenses, the XF Camera Body will indicate if LS or FPS is active on the top screen. The shutter preference can be set using the camera menu from the top screen, or from the XF menu on the IQ Digital Back. Select Capture Setup > Shutter > LS Priority / FPS Only.

Please note that if you are using the QI3 100MP digital back, you will also have the option to use the Electronic Shutter (ES) by choosing 'ES Only'. In that case, the XF Camera Body will display ES on the top screen.

Advantages of FPS (Focal Plane Shutter)

One notable advantage of FPS is ability to shoot up to 1/4000th of a second. This overcomes the use of ND filters that results in reduced viewfinder brightness and AF performance. Another benefit is the shutter response time, which is almost twice as fast as a leaf shutter. This means that if you are photographing within the FPS flash sync speed range (using flash or not), there is a shorter time lag between pressing the shutter button and the focal plane shutter being released.



Shutter preference

Advantages of LS (Leaf Shutter)

If you want to synchronize flash at a Shutter Speed faster than 1/125th of a second, for example to freeze motion or to work with wider Apertures for selective focus techniques when using balanced fill flash, the Schneider Kreuznach LS lens option overcomes the slow flash sync limitations of focal plane shutters. Another advantage is less vibration during capture due to the lower inertia of the lighter weight shutter blades. The issue of vibration, however, is addressed even on non-LS lenses with the Low Vibration mode of the XF Camera Body.

Capture One Pro



The XF Camera System is bundled with Capture One Pro

Installing on Mac

Capture One software includes an easy-to-use installer that will install all the software necessary to run the application on a Mac running Mac OS X 10.11.6 (El Capitan), macOS 10.12.x (Sierra) or macOS 10.13.x

1. Connect the supplied USB flash drive to your computer's USB port and navigate to the Capture One installer. Alternatively, you can download the latest version of the application from the Phase One website: www.phaseone.com
2. Open the Capture One Disk Image.
3. Drag the Capture One icon to the Applications folder.
4. Open Capture One from your Applications folder.

NOTE:

On Windows, Capture One will initiate installation of Microsoft® .NET Framework, if it's not already installed on your computer.

Installing on Windows

Capture One includes an easy-to-use installer that will install all the software you need to run the application on a Windows based computer.

1. Connect in the supplied USB flash drive to your computer's USB port and navigate to the Capture One install file. Alternatively you can download the latest version of the application from the Phase One website: www.phaseone.com
2. Run the executable software install file.
3. Read and accept the license agreement presented.
4. Follow the on-screen instructions to complete the installation.

System requirements

Capture One may run on other and older equipment than those listed below, but to ensure the best possible results we recommend that your computer, at the minimum, conforms to the following specifications:

Microsoft® Windows® minimum requirements

- Intel or AMD CPU with 2 cores
- 8 GB of RAM
- 10 GB of free hard disk space
- Calibrated color monitor with 1280 x 800, 24-bit resolution at 96 dpi screen ruling
- Windows 7® SP1 64-bit, Windows 8.1® 64-bit, Windows 10® 64-bit*
- Microsoft® .NET Framework version 4.7 (will be installed if not present)

*Support for Capture One 11 on Windows 10 is supported for builds supporting .NET 4.7 - This is currently from Windows 10 Anniversary Update (build 1607) through to Fall Creators Edition (build 1709)

Apple® Macintosh® minimum requirements

- CPU with 2 cores
- 8 GB of RAM
- 10 GB of free hard disk space
- Calibrated color monitor with 1280 x 800, 24-bit resolution at 96 dpi
- OS X 10.11.6, macOS 10.12.6, macOS 10.13*

*Support for macOS 10.13 is supported for builds up to 10.13.1

Recommended system requirements

The above hardware specifications are to be considered as minimum requirements. If you work with high-resolution camera systems or simply want to optimize the performance, please follow the recommendations below:

- CPU with four cores or more, e.g. Intel® Core™ i7 or better
- 16 GB of RAM or more
- Leave plenty of hard disk space free for your images
- Solid State Disk (SSD)
- A fast Graphics card from NVIDIA or AMD with 2GB+ RAM (4+ GB for 4k or multiple monitors).

Activating Capture One Pro (Mac / Windows)

An Internet connection is required to activate and update Capture One Pro.

1. Launch Capture One and select Pro, then Activate from the respective product dialog boxes.
2. Enter the 16-character license code / product key provided and your personal details to create a Profile in the required fields. (Capture One Pro license code is available inside the Capture One packaging).
3. Once you have entered the information, press the Activate... button and Phase One's server will validate the software.
4. Capture One should now be activated and ready for use.

NOTE:

A Phase One Profile is required for activation and future updates and upgrades. If you do not already have a Phase One Profile, please enter an email address and password to create a new Profile ID.

Updates to minor version releases of Capture One are free. For example, updating from Capture One Pro 10.0 to 10.1 is free. Upgrades to major version releases, for example, from Capture One Pro 10 to Capture One Pro 11, are paid for.

A Capture One Pro 11 key will activate earlier versions. For example if you prefer to use Capture Pro 10, the license code may be used for that instead. Please note this does not apply to subscriptions.

Capture One DB supports Phase One backs only, but it does not require an activation key or a license. This means that you can always use the latest version of Capture One by selecting the DB version during install and use that for free.

If you need support for other camera makes as well as Phase One, please use the paid Capture One Pro version.

Troubleshooting

If you are experiencing problems activating the software, follow the instructions provided in the application, read the Capture One help manual online, or visit our website for inspiration and troubleshooting: <http://www.phaseone.com/support>



Capture One Tethered Use



NOTES:

The IQ Digital Back is compatible with the FireWire standard which specifies cables up to 4.5 meter and USB standard which specifies cables up to 3 meters in length. Longer cables are possible, but may require a third party power solution or a powered hub. Please ask your local partner for advice on this.

The IQ Digital Back can draw power and charge the batteries in the system from the computer's ports via the interface cable. Not all computers can supply power by the data-bus, this is especially true of PC laptops with IEEE 1394 ports, and some USB ports.

A battery must be installed in the IQ Digital Back for it to function properly, regardless of whether it is exhausted or not. If it is flat and the data-bus is powered, the battery will start to be charged.

Shooting Tethered

As a professional tool for working photographers, the IQ Digital Back can be tethered to a Mac or PC running Capture One Pro raw workflow solution. In addition to being able to select and control a wide range of camera functions including exposure, focus confirmation and Live View, images can be saved to the computer's hard disk as well as the camera's CF-card, as a back-up.

Connecting to a Computer

The IQ Digital Back can be tethered to a computer using either FireWire 800 (IEEE 1394b) or USB 3.0 interface cables. (Note the IQ3 100MP series Digital Backs and the 50-megapixel IQ backs with CMOS sensors only support Live View tethering using USB 3.0.)

Online Support

For more information on shooting tethered with Capture One please consult the online user guide available in the Capture One Help menu or go direct to <https://help.phaseone.com/en/CO11/Tethered-Capture.aspx>

Tethered Capture (FireWire / USB 3.0)

To connect to a computer running Capture One, insert the supplied FireWire 800 or USB 3.0 interface cable. The ports on the IQ Digital Back are protected behind hinged covers. When connected, the camera will spontaneously power-up and the settings will be automatically shared with Capture One.

The display on an IQ Digital Back can be either turned off while shooting tethered, or set to display the images during capture (from the Camera Settings tool (Digital Back) in Capture One or the IQ menu, select Auto Preview Mode > Off / On), as if shooting untethered. It is also possible to enlarge a section of an image on the IQ screen to help check focus.

In the default Auto Storage setting, the IQ Digital Back will return to the untethered mode of operation when the interface cable is removed.

Please note that the IQ 50MP CMOS range digital backs may be tethered using FireWire 800 or USB 3.0, but only the latter option supports Live View functionality.

NOTES:

The IQ Digital Back are compatible with the Apple Thunderbolt to FireWire 800 adapter with certain restrictions, please visit the following support page for more details:
<http://www.phaseone.com/Search/Article.aspx?articleid=1256>

The IQ Digital Back are also compatible with FireWire 400. Please order a Phase One FireWire 800 to 400 cable 4.5M. Part No: 50300164.

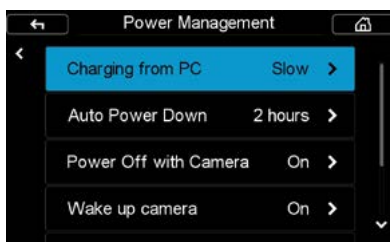

Charge when tethered

Charge when tethered

The IQ Digital Back has an integrated battery charger to ensure that the batteries are charged when shooting tethered to a computer. This charging function can be switched Off, or set to Slow or Fast. From the IQ Digital Back menu, select IQ Settings > Power Management > Charging from PC. The Slow or Off settings should be chosen to preserve the battery life of a laptop. The batteries will only charge via a USB or FireWire connection when the IQ Digital Back Power Management setting is switched to Slow or Fast.

Please note that most USB ports cannot provide enough power to charge the batteries while working or while in standby, however battery life is prolonged during charging. This is a limitation with the current USB 2.0 and USB 3.0 technology. If the back is powered off while connected via USB, it will continue to charge. Battery charging is indicated by an orange LED on the rear of the back when it has been turned off.

Import Images into Capture One Pro

The IQ Digital Back captures proprietary raw files only and require processing in Capture One or similar software to output these files as JPEGs or TIFFs. The IQ Digital Back cannot process raw files in-camera.

Import Images

Inserting a memory card into a card reader attached to a computer will automatically display the Import Images dialog window, when Capture One Pro is running.

Manual Import of images

1. Go to File and select "Import Images..." The dialog box will open to browse files.
2. Navigate to the "Import From" folder, card or disk in the Locations tool.
3. Select Capture folder (import location) and type in the job name and Metadata (copyright, caption) if desired.
4. If you want to select a naming format for the imported files, press "Format" in the Naming tool.
5. Select all or specific images to import.
6. Press "Import" or "Import All". You can continue working while images are imported in the background.

Capture One User Guide

Available in the Capture One Help menu or go direct to:
<http://help.phaseone.com>



Built-In WiFi and Capture Pilot

All IQ3 and IQ2 digital backs have built-in WiFi and can connect wirelessly with an Apple iOS device (iPhone, iPad and iPod touch) running the Capture Pilot app from Phase One. Capture Pilot enables the user to remotely control the camera's exposure settings and trigger the shutter on XF IQ3 and IQ2 camera systems. In addition, Capture Pilot allows browsing and geotagging of images, and even supports remote live view with the Phase One IQ3 50MP, IQ3 100MP, IQ3 100MP Achromatic and IQ250 MP backs.

As an option with Capture One Pro, Capture Pilot also enables remote operation and triggering of a tethered camera. The free to download app can also be a useful solution for clients wishing to view images away from computer screen, either in the studio or on location.

Note raw files are not transmitted to, or stored on, the iOS device. The original files remain on the camera's CF card and/or the tethered computer's hard disk, depending on the setup.

For more information, please see:

http://help.phaseone.com/CO1/Capture_Pilot.aspx



Download Capture Pilot from App Store

WiFi Setup

Before enabling WiFi on the IQ Digital Back please download the free Phase One Capture Pilot app from the Apple App Store and install it on your iOS device.

Version 1.10 requires iOS 9, but iOS 10 or later is recommended.

Capture Remote, the remote camera operation function of Capture Pilot is automatically enabled upon wireless connection with an IQ Digital Back.

For control of other makes of DSLRs, an in-app purchase of Capture Remote is required. Please check compatibility, before making a purchase. Note for other makes, remote control applies to cameras tethered to a computer running Capture One Pro.

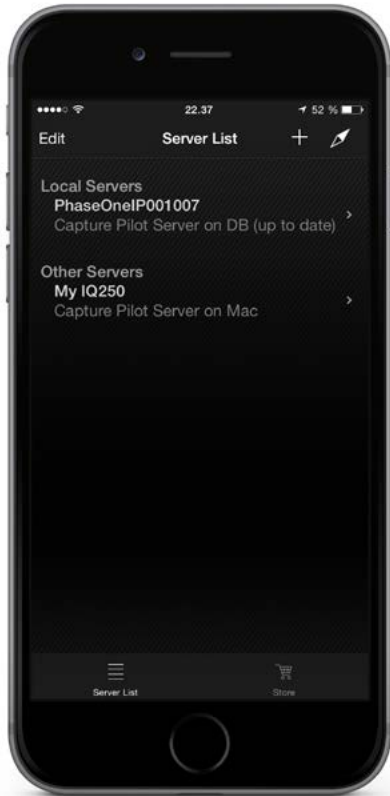

Select digital back in Capture Pilot



Choose digital back network name

WiFi Connection

There are two wireless network mode options available to connect the IQ3 digital back to an iOS device. On location, use the ad-hoc mode for a range of up to 8m / 25 ft. If the studio is equipped with a router, the infrastructure mode can be used for an extended range of up to 30m / 100 ft (depending on the equipment and signal strength).

Connect iOS device directly to IQ Digital Back using Ad-hoc mode

1. Power on the XF/ IQ3 and from the rear touch screen, select Menu > WiFi > Mode (Off) > Adhoc. This will start an image server with the network name PhaseOne[serial number]. (Note this name can be changed, see Network Security below).
2. Using the iOS device, select the Settings app > WiFi > Choose a Network... > PhaseOne[serial number].
3. Start Capture Pilot and select the IQ Digital Back's PhaseOne[serial number] network name under the Local Servers list. Enter the back's authentication (pin) code, if applicable (see Network security, for more details).
4. When connected to the IQ Digital Back, any images stored on the camera's CF card will be displayed as thumbnails.
5. To open Capture remote, the camera control tool of Capture Pilot, press the Camera icon in the menu bar at the bottom of the screen.
6. To initiate remote live view, press the movie-camera icon (IQ3 50MP, IQ3 100MP, IQ3 100MP Achromatic and IQ250 only).

Troubleshooting Connection

In general, when working in the Ad-hoc mode the WiFi settings of the iOS device should be set to Ask to Join Networks. This may prevent the iOS device automatically switching networks when the signal is lost from the IQ3, for example, when the camera is powered down. However, the iOS device will automatically join a known connection (if available), and even though the IQ Digital Back will re-enable WiFi on powering back up, Capture Pilot will be prevented from re-connecting. To re-establish the connection, from the iOS device Settings app, please reselect the IQ3 network name PhaseOne[serial number] and then open Capture Pilot.

Connect IQ Digital Back to a Router (Infrastructure mode)

1. To turn on WiFi on the IQ3, select Menu > WiFi > Mode (Off / Adhoc) > On. Wait for the back to scan for the available WiFi networks.
2. Select the studio's WiFi network name (SSID) from the IQ3 screen, Menu > WiFi > Select Network.
3. Enter the studio WiFi network's password (and user name, if applicable) on the IQ3 touch screen, using the displayed keyboard. Confirm the password with a long press on the keyboard's green check-mark button. (Note only basic ASCII (i.e. basic English) characters are supported when working wirelessly with host names, user names and passwords.)
4. To join the network, press the green checkmark. The IQ back screen displays progress, and confirms connection status.

Connecting Capture Pilot to your IQ3 via a Router

1. From the iOS device, select the studio's network from Settings > WiFi > WiFi network name (SSID).
2. Enter the studio WiFi network's password (and user name, if applicable).
3. Open Capture Pilot and select PhaseOne [serial number] under Local Servers in Capture Pilot. Enter the back's authentication (pin) code, if applicable (see Network security, for more details).
4. When connected to the IQ Digital Back, any images stored on the camera's CF card will be displayed as thumbnails.
5. To open Capture remote, the camera control tool of Capture Pilot, press the Camera icon in the menu bar at the bottom of the screen.
6. To initiate remote live view, press the movie-camera icon (IQ3 50MP, IQ3 100MP, IQ3 100MP Achromatic and IQ250 only).

The IQ3 can be remotely operated using Capture Pilot when tethered. Either wireless mode can be adopted, following the same procedure described above.

Network Security

In a large studio, there may be multiple Phase One IQ backs operating wirelessly, as well as computers running the Capture Pilot server from Capture One Pro. If that is the case, and the image servers they're publishing are in-range, your iOS device running Capture Pilot will display each device under the Local Servers list. It is possible to secure each image server with either a pin code for an IQ back, or a password for an image server published by a computer running Capture One Pro (with the Capture Pilot server enabled). Please enter the relevant code or password when prompted by the server.

Network settings on the IQ3 series digital backs include the option to change the hostname (IQ3 image server name), set a pin code, or select a specific network channel. To alter the settings select, Menu > WiFi > Mode > Off > Settings.

To reset all WiFi settings, including all network settings and pin code from the IQ3, select Menu > Restore to Default. Warning, this will reset all IQ3 settings to the factory defaults (time and date settings remain unaltered).

Using Capture Pilot

Location Data in Capture Pilot

In order to minimize the use of battery power on location, geotagging may be performed after the event at a more convenient time, for example, when back at the hotel or studio. All that's required is for Capture Pilot to be running in the background with the geotagging feature enabled and the back to set to sync automatically (Geotag CF card > On). However, it is possible to embed the data wirelessly at the time of capture (Geotag captures > On). See below for more details.

Syncing Location data after Capture

From the IQ Digital Back, select Menu > WiFi > Settings > Capture Pilot > Capture Pilot Permissions > Geotag CF card > On. When taking photographs, ensure that the Capture Pilot app (on your iOS device) is running in the background, and that the app's data-logging feature is enabled (i.e. that the compass needle button, located top right corner, is colored orange).

Note for images to be tagged accurately, ensure the time and date of the back and iOS device are synchronized.

Tagging Images Afterwards

Connecting the IQ Digital Back to Capture Pilot wirelessly (using the Ad-hoc or infrastructure mode, detailed above) will sync the location data with the files on the CF-card in the IQ Digital Back. If you have multiple CF cards with images, insert the cards into the IQ Digital Back, in turn one by one. Capture Pilot will sync with the back and automatically tag the files with the location data. Both the back and app will display confirmation that the files on the CF-card are tagged.

Tagging images at the time of Capture

Capture Pilot can be used to tag images with location data derived from the iOS device at the time of capture. From the IQ Digital Back, select Menu > WiFi > Settings > Capture Pilot > Capture Pilot Permissions > Geotag captures > On. Ensure the data-logging feature of Capture Pilot is enabled (i.e. that the compass needle button visible at the top right corner is colored orange).

A

SERIES

A-series Camera System



A-series Camera System



FLC options in the Lens Menu



A-series accessories

Phase One and ALPA provide the ultimate fine art camera system with the A-series. The only integrated and factory calibrated system of it's kind.

IQ3 A-series Camera Mode

The IQ3 A-series Camera System consists of an IQ3 A-series Digital Back, an ALPA TC A-series camera body and a Rodenstock lens. The system is delivered set by default in the A-series Camera Mode, found in the Digital Back's main menu. The A-series Camera Mode provides the system access to the factory calibrations built for each corresponding lens purchased with the A-series Camera System.

The A-series Camera System is used in Normal latency using an identical workflow for any technical camera system, syncing the mechanical lens with the A-series Digital Back through the provided standard Sync Cable. Please note the Zero latency mode on the A-series Camera System should not be used. Please read page 95 for more on how to perform a two-shot release procedure on a technical camera.

Factory Lens Calibrations (FLC)

Each A-series Camera System is custom built and calibrated to include a Factory Lens Calibration. This FLC is built for the specific IQ3 A-series Digital Back and Rodenstock lens that are selected at the time of purchase. The necessary FLC's are saved within the IQ3 A-series Digital Back and can be accessed when changing lenses from the Lens menu of the Digital Back. Please note that if you are using a lens other than those initially purchased with the IQ3 A-series Camera System, you must choose "Other" from the Lens menu.

Sync Cable

The "ALPA Sync Cord Mark II" be connected in three places to the A-series Camera System, the Rodenstock lens' flash sync port, the "ALPA Sync Release Mk II" and to the 8 pin multi-connector port on the left side of the IQ3 A-series digital back.

Live View

Live View option for focussing and composition, particularly the CMOS based IQ3 A-series digital backs, is easily accessed on the Rear Touch Screen, through Capture Pilot on an iOS device or through Capture One software.

To access Live View on the Rear Touch Screen:

1. Open the lens shutter using the lens' Preview Lever.
2. Press the Contextual Menu icon on the Rear Touch Screen
3. Press the Live View icon
4. To end Live View press the Upper Left Key on the IQ3 A-series Digital Back and remember to close the lens shutter using the lens Preview Lever.

To access Live View from Capture Pilot repeat steps 1 and 4 above, while substituting steps 2 and 3 with the Live View button found in Capture Pilot's Capture Control Tool (page 84).

Open Platform Design

The IQ3 A-series Camera System is built to retain complete compatability with the XF Camera System. Simply mount the IQ3 A-series Digital Back on an XF Camera Body and change the Camera Mode to Normal.

More information is available from ALPA of Switzerland at: <https://www.alpa.ch>

Front right hand side

The A-series Camera System embraces the excellence of decades-old analog technology and pairs it with unmatched digital integration.



Left hand side



IQ Digital Backs and Cambo Technical Cameras



Exposure and shutter release

The Cambo Technical Camera solutions features a Copal shutter. Depending on the use case and digital back used, a cable release needs to be attached to the release socket of the mechanical shutter. The Copal O shutter supports shutter speeds between 1/500 and 1 second. It also supports Bulb and Toggle shutter functionality. Note that the mechanical shutter must be cocked between every exposure unless you are using the Electronic Shutter (ES) on the IQ Digital Back (where applicable).

There are three ways to operate the Cambo and IQ Digital Back solution with regards to setting the exposure, releasing the shutter and capturing and image:

1. Electronic Shutter (ES)
2. Two-Shot shutter release procedure
3. Zero Latency shutter release

These operations are explained one by one on the following pages.





Shooting with the Electronic Shutter (ES)

Using the Electronic Shutter (ES) on applicable IQ Digital Backs makes the shutter release operation faster and easier as there is no need to cock the mechanical shutter between every exposure.

It should be noted, however, that it takes a noticeably longer time to read the entire image from the sensor when using the Electronic Shutter rather than the mechanical shutter. The full read-out time is typically up to one and a half second, so Electronic Shutter is mostly useful for product shots or landscape photography, where there are only small local movements (for example, leaves, trees or waves). Due to the readout time, larger moving subjects (for example a moving car or running persons) will be distorted in the image. As a consequence, the Electronic Shutter is best suited for tripod use.

Shooting with Electronic Shutter (ES)

It is recommended to trigger the Electronic Shutter (ES) with a remote release like the Phase One Break Out Box (part number 73130). In order to connect it to the 8-pin multi-connector port on the applicable IQ Digital Back, you will need the Cable Release Adaptor (part number 73174). Plug the adapter into the 8-pin multi-connector port on the side of the IQ3 Digital Back, while the other end of the adaptor should be connected to the Phase One Break Out Box.

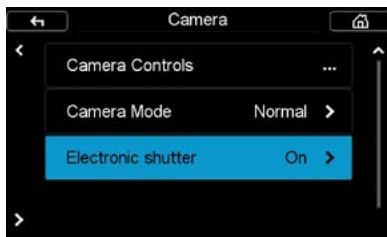

Enabling Electronic Shutter

You first need to make sure that the Electronic Shutter is enabled on the Digital Back by selecting Menu > Camera > Electronic shutter > On.



Make sure that the shutter is open by using the Preview Lever (1) on the lens. The shutter is open when the red dot is visible.

Enter Live View in the applicable IQ Digital Back by tapping on the contextual menu icon (A) of the Rear Touch Screen, then press the Live View icon (B). You can also enter Live View from the Camera Controls screen mention on the next page.



Make any desired adjustments to Tilt, Shift and Swing on the Cambo Technical Camera.

Adjust focus (2). If you want to review the depth of field, remember to close the aperture down to the desired working value with the Aperture Selector (3) on the lens.

You can capture using the Electronic Shutter directly from live view, or exit Live View to wait for the desired moment of capture.

Adjust the aperture on the lens with the Aperture Selector (3), if needed.

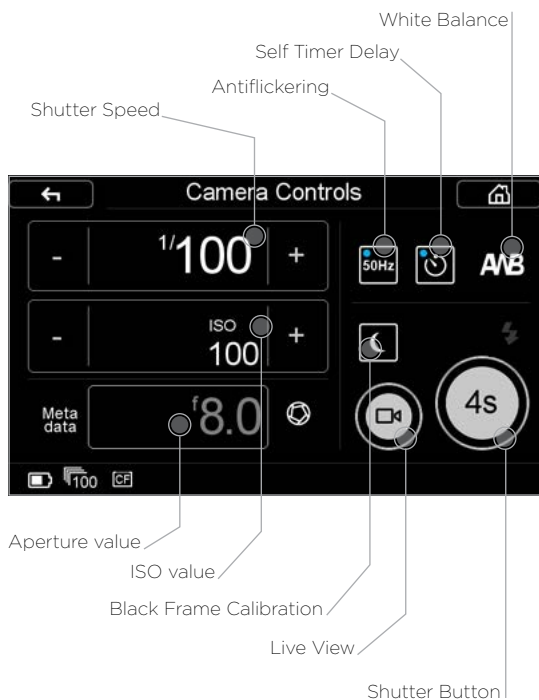

You can adjust the shutter speed and ISO by using the Camera Controls. Tap on ES on the touch screen to open it.



Then simply touch the shutter speed or ISO values to change them. Note that since the aperture is set on the lens, you will need to enter the used aperture value in order for it to be written correctly into the metadata of the image.

Once you all your settings in place, just press the shutter button to start the exposure.

Recording a Black Frame Calibration

A Black Frame Calibration is a necessary step of the IQ Digital Back to ensure image quality excellence. The Black Frame Calibration is integrated into the RAW file, at the time of capture, to provide a basis for the black point of the image and thus ensure full effectiveness of the IQ Digital Backs dynamic range, color fidelity and image richness. A Black Frame Calibration is essential for every capture of an IQ Digital Back. This calibration is made automatically on an integrated system, however on a technical camera solution some element of manual oversight to execute this calibration is necessary.

Recording a black frame calibration cannot be done fully automatically when using the Electronic Shutter in conjunction with a technical camera as the IQ Digital Back has no feedback from the lens. When a black frame calibration is needed, the IQ will prompt you to close the shutter during the black frame calibration capture. This is done with the Preview Lever on the lens. You can also place the lens cap over the lens (Page 91, figure 1).

Once the shutter is closed, you can confirm via the prompt on the IQ Digital Back and the Black Frame Calibration will be completed.

You can choose between three different settings for the black frame calibration. This is done by tapping on the Black Frame Calibration icon and then cycling through the three options. You can choose between:

- **Normal.** The IQ3 initiates a black frame calibration whenever needed. This will happen when you change the shutter speed or ISO, or a certain amount of time has passed since the last capture. This is the default setting and a new Black Frame Calibration will be requested when the IQ Digital Back deems it necessary based on very tight tolerances.
- **Always.** The IQ3 will always make a black frame calibration between each capture. This option is shown with a blue dot on the icon. This setting will ensure each and every capture provides the absolute best Black Frame Calibration as one will be made immediately following each capture, under almost the exact same conditions as the image capture.
- **Suppress.** The IQ3 will not make a new black frame calibration if the Digital Back determines that a change to the exposure is minimal and will not notably impact the image quality. This operation widens the tolerances requiring a Black Frame Calibration and may improve the speed of your workflow but will ultimately not provide the absolute best option to retain image quality. This option is shown with a red cross over the icon.

Once the Black Frame Calibration is done, remember to open the mechanical shutter again with the Preview Lever on the lens or remove the lens cap.

If you continue to shoot with the same exposure values, you will not be prompted to make a new Black Frame Calibration after each capture if you have selected the default Normal mode. This makes the Electronic Shutter the most convenient way to capture multiple images of the same subject with a technical camera.

Shooting with a two-shot release operation

The IQ Digital Back is equipped with two shutter latency mode settings; Normal and Zero latency. With the IQ Digital Back set to Normal latency, because of the “sleeping” architecture of IQ Digital Back, the digital back must be triggered twice to provide the sensor a “wake-up” signal before it can initiate the capture.

The advantage of using Normal latency is that the sensor does not have to be awake at all times. This both saves energy and makes sure that the sensor temperature doesn’t rise unnecessarily over time, potentially degrading image quality by causing unwanted noise.

This operation requires a special two-shot sync cable. The first release activates the IQ Digital Back with the wake-up signal, and the second initiates the exposure. There are several automatic, or semi-automatic, two-shot solutions (sometimes referred to as wake-up cables) available for use with a mechanical shutter.



Connect one end of the Wake-Up Cable (part number: 50300131) to the flash-sync port on the lens’ mechanical shutter and the other end to the Multi Conn. to Mini Jack Adaptor Cable (part number: 50300144). Then connect the sync cable to the multi-connector port on the IQ Digital Back.

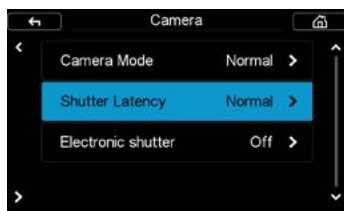

Enabling Normal Shutter Latency

Ensure that Shutter Latency is set to Normal mode on the IQ Digital Back under IQ Menu > Camera > Shutter Latency > Normal.

Instructions continue on the next page.



6. Wake-Up Button on the Wake-Up cable



Using the two-shot release procedure

Make sure that the shutter is open by using the Preview Lever (1) on the lens. The shutter is open when the red dot is visible.

Enter Live View in the IQ3 Digital Back by tapping on the contextual menu icon (A) on the Rear Touch Screen, then press the Live View icon (B).



B: Live View A: Menu

Make any desired adjustments to Tilt, Shift and Swing on the Cambo Technical Camera.

Adjust focus (2). If you want to review the depth of field, remember to close the aperture down to the desired working value with the Aperture Selector (3) on the lens.

Exit Live View on the Digital Back.

Adjust the aperture with the Aperture Selector (3) on the lens, if needed.

Adjust the shutter time with the Shutter Speed Selector (4).

The ISO value is adjusted on the IQ Digital Back by pressing ISO on the home screen.



Close the shutter with the Preview Level (1), so the red dot is hidden.

Spring-load the mechanical shutter by using the Shutter Cocking Lever (5) on the lens.

Push the button (6) on the Wake-Up cable to alert the IQ Digital Back to get the sensor ready for the capture, then slowly trigger the mechanical shutter via the shutter release cable.

If the time span between pushing the Wake-Up button and the shutter release is more than four seconds, the capture will be abandoned and the IQ Digital Back will give you the error "Delay between TwoShot Pulses too long, should be max. 4 sec."

Remember that you need to spring-load the shutter again by using the Shutter Cocking Lever (5) before every new capture.

If you have an automatic two-shot solution, like that one shown in the image on the left, you do not need to wake up the sensor first as the integrated cable solution will facilitate this action. Using an automatic two-shot solution therefore allows you to disregard the "Wake-Up" step above.

The automatic two-shot solution is designed to wake the digital back sensor automatically as you start to press the shutter release and then capture the image when the shutter release is fully pressed. It is recommended to trigger the shutter release slowly to give the digital back a bit of time to wake the sensor.



Zero Latency Shutter Release operation

The IQ Digital Back is equipped with two shutter latency mode settings; Normal and Zero latency. With the IQ Digital Back set to Zero Latency, the back will automatically sync with the mechanical shutter once you press the shutter release. This mode saves you the extra step of having to “wake-up” the sensor manually, which is required with the Normal latency mode, as the sensor is always on.

It is important to note that the Zero Latency mode will keep the sensor awake at all times and that the temperature, as a consequence, can raise over time potentially degrading image quality. This is especially true if shooting in high ambient temperatures. For this reason, you should either turn the IQ Digital Back off when not shooting, or only enable Zero Latency before a capture, then return the latency mode setting to “Normal”.

Connect a standard (one-shot) Sync Cable between the PC Sync Port connector on the lens’ mechanical shutter and the multi-connector port on the IQ Digital Back (part number 50300143).

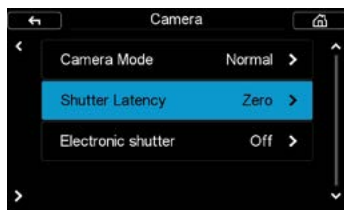

Enabling Zero Latency

You enable Zero Latency by selecting the IQ Menu > Camera > Shutter Latency > Zero. Choose Shutter Latency > Normal to turn the mode off again.

Instructions continue on the next page.



Shooting with Zero Latency

Make sure that the shutter is open by using the Preview Lever (1) on the lens. The shutter is open when the red dot is visible.

Enter Live View in the IQ Digital Back by tapping on the contextual menu icon (A) of the Rear Touch Screen, then press the Live View icon (B).



Make any desired adjustments to Tilt, Shift and Swing on the Cambo Technical Camera.

Adjust focus (2). If you want to review the depth of field, remember to close the aperture down to the desired working value with the Aperture Selector (3) on the lens.

Exit Live View on the Digital Back.

Adjust the aperture with the Aperture Selector (3) on the lens, if necessary.

Adjust the shutter time with the Shutter Speed Selector (4).

The ISO value is adjusted on the IQ Digital Back by pressing ISO on the home screen.



Close the shutter with the Preview Level (1), so the red dot is hidden.

Spring-load the mechanical shutter by using the Shutter Cocking Lever (5) on the lens.

Push the shutter release cable to make the capture.

Remember that you need to spring-load the shutter again by using the Shutter Cocking Lever (5) before every new capture.

Using Lens Cast Calibration



Phase One LCC Plate

Some lenses on a technical camera are positioned very close to the sensor surface of the IQ Digital Back, which can result in color cast and luminance uniformity issues which ultimately effect image quality. Tilt and shift movements can also introduce, or accentuate, the issue. The LCC (Lens Cast Calibration) tool in Capture One Pro is designed to correct for the color and luminance uniformity conflicts by analysing and applying a correction made from a LCC capture.

To use the LLC tool, you will need to make an LCC capture. An LCC capture is a photograph of an evenly-lit semi-transparent card, used as a reference image within Capture One's LCC Tool. In order to create an accurate LCC profile, the reference capture should ideally be made with the same lens, aperture setting, and light conditions as the images you wish to correct. In order to accommodate for the loss of light from the semi-transparent card, it is suggested to decrease your shutter speed by two stops. Tilt and shift adjustments on a camera must also match for the best results.

Creating an LCC profile in Capture One

1. Once you have made an LCC reference capture, select the RAW file it in Capture One and go to the LCC tool. Then click on **Create LCC**.
2. Enable the **Wide Angle Lens with Movements** option if you are using a wide-angle lens and some degree of movements like tilt or shift lens. You can also enable the **Include Dust Removal Information** option to create a map which automatically removes dust. Note that this will increase processing time.
3. Click **Create**. Capture One now analyzes the reference image and creates an LCC profile.
4. When completed, the reference image used will be labelled with **LCC** in the browser to help you keep track of your profiles. The created LCC Profile will be applied automatically to the reference shot, letting you check immediately whether it was successful. It should show an evenly exposed light grey image without a color cast, vignetting or dust spots if you have selected that option. It may be necessary to white balance the image to evaluate the proper application of the LCC.

Workflow tip: If you have multiple LCC reference shots to calibrate, you can save time by selecting them all and click on Create, then Capture One Pro will work through them one by one.

Applying an LCC profile

You apply an LCC profile to an image by first selecting the **LCC** reference shot and then the image in the Browser, then go to the **Adjustments** menu and select **Apply LCC**. You can also right-click on the image in the Browser and select **Apply LCC**.

Note that you can select multiple images and apply the same LCC profile to them all by using the same process.

Adjusting the LCC profile effect

Once an LCC profile has been applied, you can fine-tune its effect on the image with the LCC Tool. You can turn the color cast correction on and off with the **Color Cast** option as well as the **Dust Removal** if any dust was found on the reference image. You can also control the correction of Light Falloff with **Enable Uniform Light** and the **Uniform Light** slider. You might, for example, want to dial the correction down a bit to 75% with the slider in order to retain some of the light falloff.

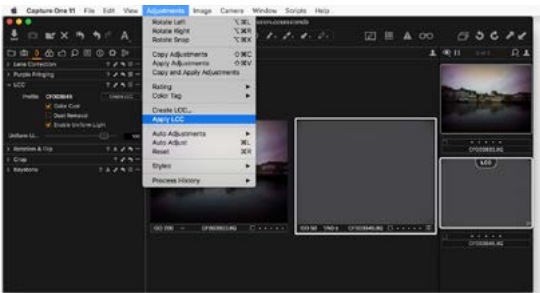
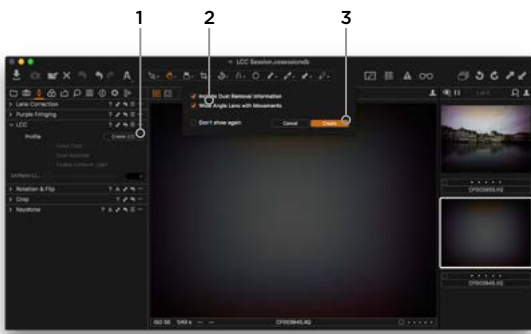

IQ Digital Backs with third party cameras



Phase One IQ Digital Backs are manufactured with specific mounts and digital interfaces for optimal performance with Phase One / Mamiya cameras and Hasselblad medium format camera bodies.

The standard IQ Digital Back is equipped with an M mount for use with the Phase One XF or Phase One / Mamiya DF+ camera body, however IQ Digital Backs may be ordered with specific Hasselblad H or V mounts. In some cases, IQ Digital Backs can be fitted with an adapter to fit other camera body mounts. Please note the IQ series cannot be ordered with a C mount for the Contax 645 body.



Mamiya RZ67 PRO II/D

Mamiya RZ67 PRO IID

The IQ Digital Backs with a standard M mount for use with the Phase One XF or 645DF+ are compatible with the Mamiya RZ67 Pro IID camera, however this will require an additional adaptor plate. (Phase One Part # 70994)

It is also possible to use a Phase One IQ Digital Back with Hasselblad V mount on the Mamiya RZ67 PRO IID. Modification of the back mount plate is required with the following Mamiya service part number: Y22995-RZ.

Mamiya RZ67 PRO II

The Hasselblad V mount version of an IQ Digital Back can only be used on the older version Mamiya RZ PRO II with the Mamiya RZ67 Pro II adaptor. (Phase One Part# 70964). Please note, the standard M mount IQ Digital Backs are not compatible.

Viewfinder Masking

Please check the relevant Mamiya RZ67 manual regarding how to detach the viewfinder and remove the focusing screen.

1. Remove the protection tape from the mask.
2. Detach the prism or waist-level finder and remove the focusing screen.
3. Place the viewfinder mask in the bracket that holds the focusing screen.
4. Re-mount the focusing screen followed by the Viewfinder.

Mamiya RZ Pro II mode selector

The mode selector on the trigger button should be turned to the white dot when used with the IQ Digital Back. The selector should be set to the orange dot to avoid draining the internal (back-up) battery of the RZ camera when the IQ Digital Back is attached to the body and not in use.

IQ Digital back Camera Mode setting

Select the specific Mamiya RZ67 PRO IID camera mode on the IQ Digital Back, Menu > Camera mode > RZ67PROIID. This will ensure that the IQ Digital Back operates optimally. Note this option is not relevant for the earlier Mamiya RZ67 PRO II model.



Viewfinder Masking



Mamiya RZ Pro II mode selector



IQ Digital back Camera Mode setting



Hasselblad H-series Cameras

Phase One IQ Digital Backs incorporating a Hasselblad H mount can be fitted to most early Hasselblad H-series cameras, including the Hasselblad H1 and H2.



Viewfinder Masking

Viewfinder Masking

Please check the relevant Hasselblad H-series manual regarding how to detach the viewfinder and remove the focusing screen. Masking is only required for the 50MP or 40MP IQ Digital Backs.

1. Remove the protection tape from the mask.
2. Detach the Viewfinder and remove the focusing screen.
3. Place the viewfinder mask in the bracket that holds the focusing screen.
4. Re-mount the focus screen, followed by the viewfinder.



Hasselblad H-series Camera Display

Hasselblad H-series Camera Display

The Hasselblad H-series grip-screen can display some information from the Phase One IQ Digital Back. Information includes the ISO setting of the IQ Digital Back and certain error messages, for example, "Digital back storage media is full".

Please note, ISO settings should be set from the IQ Digital Back or in Capture One Pro software when shooting tethered.

All the Hasselblad H-series camera auto exposure modes are fully supported by the IQ Digital Back. Please check the relevant Hasselblad H-series manual for more information on exposure modes.



Hasselblad V Cameras

Phase One IQ Digital Backs incorporating a Hasselblad V mount can be fitted to most Hasselblad V cameras, including Hasselblad 555 ELD, 553 ELX, 501 CM and 503 CW models.

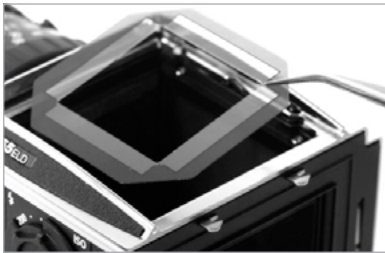

Viewfinder Masking

Viewfinder Masking

Please check the relevant Hasselblad camera manual instructions before removing the focus screen.

1. Remove the protection tape from the mask.
2. Dismount the finder and remove the focusing screen.
3. Place the mask in the bracket that holds the screen.
4. Re-mount the focusing screen, followed by the Viewfinder.



Vertical Mounting

Vertical Mounting

On the Hasselblad V it is possible to mount the digital back in vertical position, in order to make portrait oriented images.



Sync Cable

A sync cable must be connected from the lens to the small connector port in the front plate on either the left or right side of the IQ Digital Back, regardless of which Hasselblad V type camera used.

Motor cable

For ELX or ELM bodies, a motor cable is supplied with the V mount digital back to enable users to fire the camera from within Capture One Pro. This is not required with the Hasselblad 555 ELD body.



Flash Lead Connection

Flash Lead Connection

A flash cable can be connected to the Flash port connector on the IQ Digital Back.

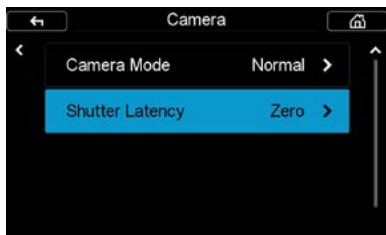

Shutter Latency Setting

Shutter Latency Setting

The IQ Digital Back is equipped with both Normal and Zero latency mode settings for optimal performance with certain camera functions. Set the latency setting to Zero if using the Mirror Up function, or if you need to rapidly press the shutter button. Do not to trigger the shutter too fast when using Normal latency. On 903 CW and 905 CW, set the IQ Digital Back latency to Zero .



Hasselblad 555 ELD

Hasselblad 555 ELD

Ensure that the shutter release on the front of the 555 ELD is in the DIG position



DIG position

IQ Digital Backs and Technical Cameras



Phase One IQ Digital Backs are compatible with a wide range of technical cameras with the relevant body mount or adaptor, and the Live View option for focussing and composition makes it a compelling solution, particularly the CMOS based IQ Digital Backs.

IQ Digital Back Latency and Mechanical Shutters

The IQ Digital Back is equipped with two shutter latency mode settings; Normal and Zero latency. With the IQ Digital Back set to Zero latency (select IQ menu > Shutter Latency > Zero), the back will sync with the mechanical shutter on the first release. Connect a standard (one-shot) sync cable between the flash-sync port on the lens' mechanical shutter and the multi-connector port on the IQ Digital Back. Please note the Zero latency mode consumes more battery power, as the back's power management features are overridden.

With the IQ Digital Back set to Normal latency, battery life is extended but the mechanical shutter of the technical camera must be tripped twice within a four-second time frame. This requires a special two-shot sync cable. The first release of the shutter activates the IQ Digital Back with a wake up signal, and the second initiates the exposure. If the time limit of four-seconds is exceeded, the IQ Digital Back gives a warning 'beep' followed by a 'two shoot error' display on the screen.

There are several automatic, or semi-automatic, two-shot solutions (sometimes referred to as wake-up cables) available from third party manufacturers to use with a mechanical shutter. Please ask your dealer for more information.

Typical two-shot release procedure

1. Connect a two-shot sync cable to the multi-pin port on the IQ Digital Back, and connect the other end of the cable to the flash sync port of the mechanical lens. If flash is required, connect a flash sync lead to the IQ Digital Back.
2. Ensure Normal latency is selected on the IQ Digital Back.
3. Close, or stop-down, the lens to the taking aperture, if necessary.
4. Push the trigger down slowly on the shutter release cable. The two-shot cable will ready (wake-up) the IQ Digital Back and take a shot when it is pushed all the way down.

Electronic Shutters

Several vendors make automatic lens controls that are compatible with the IQ Digital Backs - Please ask your dealer for more information.

More information is available by searching for specific camera names in the Phase One Knowledge base at: support.phaseone.com

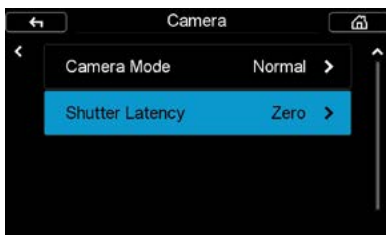

Zero latency setting

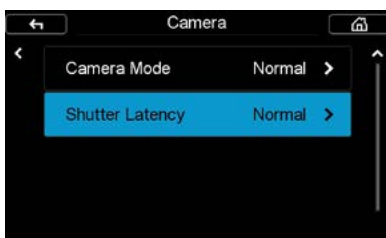

Normal latency setting

System Maintenance

Keeping your XF Camera clean

Your XF Camera System generally needs very little maintenance. However, as this is a professional tool it should be treated with proper care and caution. Always perform test shots before a photographic session if the camera, for any reason, has not been used for a long period of time.

Note: If the camera is suddenly taken from a cold to a warm place, condensation may form on the camera and internal parts. In this case, do not use the camera. Instead remove the lens, CF card and batteries from both the XF Camera and the Digital Back. Then wait until the condensation has evaporated before using the camera again.

XF Camera Body

Keep the electronic contacts and back mount of the XF Camera Body clean and free of dust with a dry microfiber cloth, but do not re-use the cloth on the lens' surface. If the camera has been exposed to salty air, wipe it clean with a well-wrung wet cloth.

To clean the screen on the QI Digital Back or the Top Touch Screen on the XF Camera, wipe it using a microfiber cleaning or soft dampened cloth. This will remove dust, dirt and fingerprints from the screen without scratching or streaking.



WARNING: Do not use any solvents or liquid-based cleaners as these substances may damage the LCD screen coating. Never touch the electronic contacts with your fingers as this can lead to corroding of the contacts and camera system malfunction.

Lenses

If there is any dust on the surface of optics, first try to remove it with a rocket air blower. Never use compressed air unless the product is made specifically for photographic equipment, since the propellant can leave residue on the glass surface that can be very difficult to remove.

If there are smudges on the lens surface, use the dry lens cloth that was supplied with the lens. Make sure to remove as much debris as possible with an air blower first, so you do not end up grinding the debris into the glass. It might be necessary to moisten the lens cloth with a fluid lens cleaner. Then use a circular motion to gently remove smudges from the lens surface, working from the center outward. Dust and smudges on the rear element of the lens will have the most impact on image quality so make sure to clean this part regularly.

Please note the lens is not waterproof. If it becomes wet, it should immediately be dried with a cloth. If the lens is exposed to salt spray, moisten the cloth and carefully clean the lens.



WARNING: Never touch the optics of the lens with your fingers. Do not use chemicals on a lens tissue or cleaning cloth that are not specifically made for lens cleaning. Facial tissue is not recommended, as some brands are abrasive and others contain oils and lotions that can streak your lenses. Do not touch the electronic contacts with your fingers.



Prism Viewfinder

Dust or dirt on the viewfinder will never impact the image quality, but can be quite distracting during a shooting session. Detach the viewfinder and first try to remove the dust with a rocket air blower. Then, if there is still some debris or smudges, simply moisten a lens cloth to wipe the smudges away. It is easier to clean the diopter if you remove the rubber eyepiece first by grasping the sides and pushing it upwards. Remember to clean the large glass plate at the bottom of the viewfinder too.

Note: Never use chemicals as they might leave streaks on the viewfinder.



Focusing Screen

The focusing screen is a very delicate part that can easily be damaged. If you observe any dust or dirt on the top outside of the focusing screen, you can gently try to remove it with a rocket air blower. If the dirt seems stuck, do not attempt to use force to remove it, but instead contact your reseller or a service center for guidance on how to get it cleaned. If you observe dust or dirt on the inside of the focusing screen, you should also contact your reseller for guidance.

WARNING: Never use compressed air to clean the focusing screen unless the product is made specifically for photographic equipment and do not touch the screen with any tools or your fingers. Scratches to the focusing screen is permanent and cannot be removed.

Cleaning the Sensor on IQ Digital Back

The Phase One IQ Digital Back should always have the protective sensor cover fitted when not attached to a camera. Dust may accumulate on the IR filter of the sensor, which will degrade the image quality if not removed. When cleaning the sensor, please use the Phase One Sensor Cleaning Kit that is supplied with the IQ Digital Back.



Instructions for sensor cleaning:

1. First try to remove any dust or debris with a rocket air blower. This will ensure that no hard particles like sand can scratch the IR filter during the following steps.

WARNING: Never use compressed air unless the product is made specifically for photographic equipment, since the propellant can leave residue on the surface that can be extremely difficult to remove.



2. Locate the small scraper in the supplied Sensor Cleaning Kit and use either the wide (42 mm) or normal (38 mm) end that matches the width of your sensor. Ensure that no dust or loose material is present on the edge of the scraper.

3. Select a cloth from the Sensor Cleaning Kit and fold it over the scraper so that you have two layers of cloth.



4. Apply 2-3 drops of eclipse fluid from the Sensor Cleaning Kit to the edge of the folded cloth.



5. In one motion, swipe the surface of the sensor from one end to another. Do not swipe a second time in the opposite direction.

6. Inspect if the sensor is clean by holding it into the light. If necessary, move the cloth layer one cm on the scraper and repeat the process. Never swipe two times with the same area of the cloth as the removed dirt could risk being reapplied to the sensor.

For quick sensor cleaning during work in the field you can use an air blower or the supplied E-wipe cleaning cloths. These can be used with same procedure as outline above, just skip adding the Eclipse fluid.

Note: The IR filter (Infrared Reduction Filter) is permanently mounted on top of the sensor. The filter may not be removed for several reasons:

1. Focus accuracy is dependent on the presence of the IR filter.
2. It is only possible to remount the filter without dust degrading the sensor if you have access to special clean room facilities.
3. The Phase One Product Warranty will be void.

XF Camera System Status



System Status, screen one



System Status, screen two

Checking the XF Camera System Status

You can easily check whether all parts of the XF Camera System is working correctly by tapping on the Battery icon on the Top Touch Screen. The Status screen will show a green checkmark if all is well, a red cross if there is an error, and a white cross is something is missing, like the Viewfinder. Note that you can scroll down with the Front Dial to reveal further information.

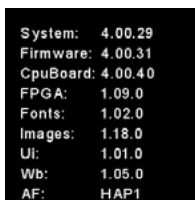

About info, screen one

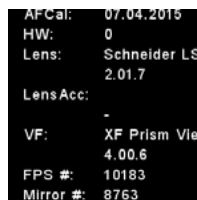

About info, screen two

Checking hardware and software versions

You can access detailed information about both the hardware and software versions on your XF Camera System by pressing the Rear Key and selecting the menu item About. Note that you can scroll down with the Front Dial to reveal further information like the number of shutter release cycles.

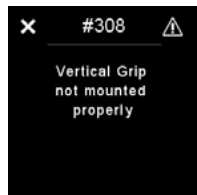

Error message on XF top screen

Error Messages

The XF Camera System has a comprehensive list of error messages that will appear on either the Digital Back screen or the XF Camera top touch screen, depending on the issue that is encountered. The error messages will make sure that you know what to do if some sort of issue arises.

Please note that some of these messages are just notifications that will prompt you to change a user setting or for example remount the Vertical Grip for a better connection. If the error encountered is deemed to be more severe, you will get a message to contact support.

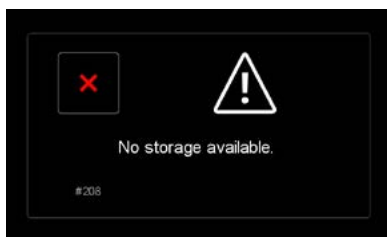

Error message on IQ Digital Back screen

Updating the XF Camera Firmware



Updating Firmware from the IQ Digital Back

How to update the XF Camera System Firmware

To install a Feature Update, simply download it from the Phase One website and copy the camera package file (with the file extension .fwp) to the root folder of a CF card.

1. Place the IQ Digital Back on the XF Camera Body.
2. Make sure your installed batteries are fully charged on both the XF Camera Body and IQ Digital Back.
3. Insert the CF card into the IQ Digital Back.
4. From the IQ Digital Back home screen select Menu > Firmware > Update Firmware.
5. The XF Camera System will now update with all relevant firmware updates.

Please do not interrupt the updating process. Should this happen by mistake, the update will fail and you will have to run the update again.

Note that the firmware update process runs an assessment of what firmware files are needed for both the XF Camera and the IQ Digital Back. After this assessment is completed, the firmware will be updated on all units with relevant corresponding firmware.

If you disconnect the Digital Back from the XF Camera, the firmware will only be updated on the IQ Digital Back. This might result in some features not working correctly on the XF Camera with an older firmware and it will be necessary to repeat the firmware update with the IQ Digital Back attached to the XF Camera to enable all features.

Instructions for changing the focusing screen



Changing the focusing screen is not a trivial task, and should only be done by an experienced person or a Phase One Service Center.

Note: There are two different procedures for changing the focusing screen, depending on which version of the XF Camera Body you have.

XF Camera bodies with a serial number up to RA003841 require that the focusing screen is changed through the mirror box, while models produced after Nov. 9th 2016 with serial number higher than RA003841 have the focusing screen changed from the top of the XF Camera Body.



Please check the serial number on the bottom of your XF Camera Body, and proceed to the section below that matches your camera version.

WARNING:

Since the focusing screen's surfaces are soft and easily damaged, handle them with care. Never touch the surface with bare fingers. Should dust settle on it, simply blow it away with a blower. If the focusing screen needs cleaning, send it to the nearest authorized Phase One Service Center, instead of attempting to clean it yourself, as it is very delicate. Do not touch the mirror in any way, as its surface is easily damaged.

Instructions for changing the focusing screen for cameras with a serial number up to RA003841.

WARNING:

Before you proceed, make sure that the batteries are fully charged, as the XF Camera System must be powered on throughout the procedure in order to keep the mirror in its down position.



Remove the prism viewfinder or waist level viewfinder from the XF Camera Body. This will make it much easier to see inside the mirror box.

Power on the Digital Back on the XF Camera Body. This will drop the mirror. Remove the lens, and tilt the XF Camera Body backwards with your hand so that you can access the mirror box more easily.

Locate the focusing screen frame release lever, and pull it forward towards you with the supplied tweezers.



This will release the frame, and the focusing screen will drop down in the mirror box.



Carefully remove the focusing screen from its frame by grasping the tab on the edge of the screen with the tweezers. Make sure that you do not scratch or touch the focusing screen or the mirror while removing it from the mirror box.

Instructions continues on next page..



When installing a new focusing screen, pinch the tab of the screen with the tweezers, and place the screen onto the frame. When performed correctly, the focusing screen should easily settle into the frame. Make sure that the tab is on the right side, otherwise the focusing screen will be upside down.



Push the screen frame upwards using the tweezers, while being careful not to touch the focusing screen or the mirror.



Press the frame upwards into position near the release lever until you hear a clicking sound. The screen is now properly installed.

Instructions for changing the focusing screen for XF Cameras with a serial number higher than RA003841.



Remove the digital back and lens from the XF Camera Body. Next, remove the prism viewfinder or waist level viewfinder from the XF Camera.

Locate the focusing screen frame release lever and push it towards the lens mount with the supplied tweezers. This will release the focusing screen and its frame.



Slowly tilt the XF Camera Body backwards until the focusing screen frame tilts out and downwards.



Continue with the tilting movement until the focusing screen follows the frame down, then rest the camera body on its back.



Carefully remove the focusing screen from its frame by grasping the tab on the edge of the screen with the tweezers. Make sure that you do not scratch or touch the focusing screen while doing so.

Instructions continues on next page...



When installing a new focusing screen, pinch the tab of the screen with the tweezers, and place the screen onto the frame and as far as possible into the back end of the frame. Make sure that the tab is on the left side, otherwise the focusing screen will be upside down.



Push the screen frame upwards by pressing the tweezers against the corner of the frame.



Slowly tilt the XF Camera Body to its upright position, while keeping the tweezers against the frame, as shown.



Finally, press the frame downwards close to the screen release lever until you hear a click. The screen is now properly installed.

Learning More

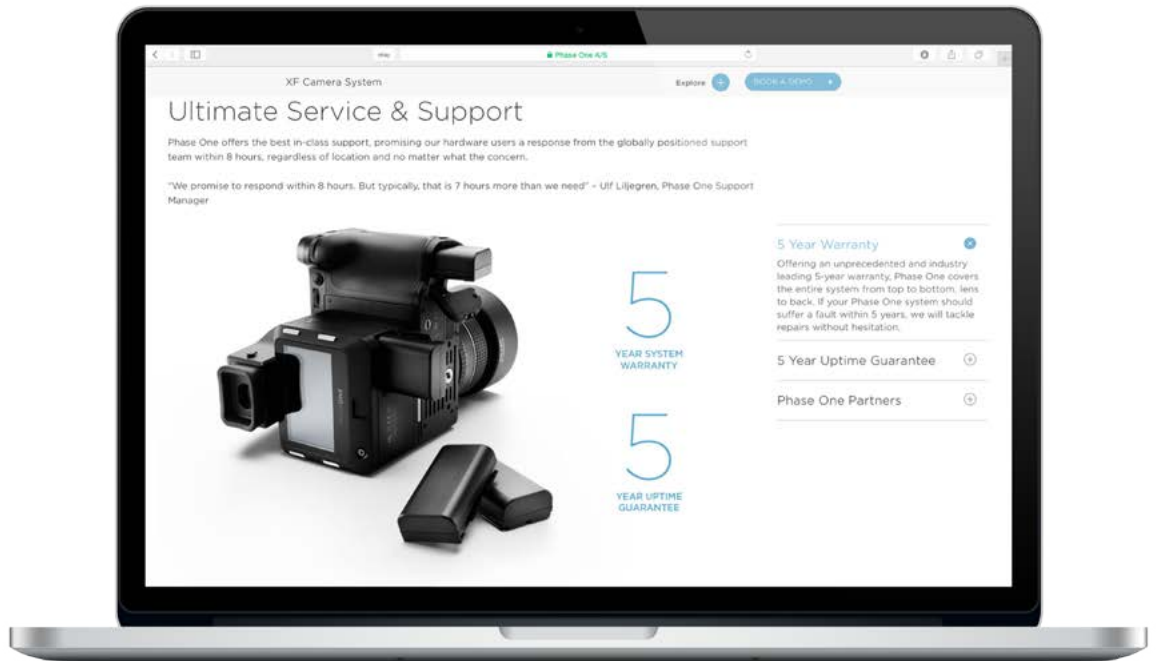

Phase One Customer Service

The Phase One XF Camera System is a high-performance camera designed to endure the rigors of daily professional use under a wide range of environments. However as a precision made optical and mechanical device it should be protected from harsh use, and stored carefully away from extremes of temperature and humidity when not in use.

If the camera is to be stored for an extended period, remove the batteries and store them safely (to prevent shorting and the risk of fire).

Service and Repair

In the event of damage, or if your Phase One equipment requires servicing, please either contact Phase One or a Phase One subsidiary at www.phaseone.com/contact, or reach out to your Phase One Partner at www.phaseone.com/partners

Phase One Technical Support

For support concerning Phase One hardware or Capture One software, including license and activation issues, please contact a member of the Phase One Technical Support team online at: support.phaseone.com

If you are not a registered user, please sign up for timely notifications of firmware and software updates and news of the latest developments. If you have downloaded and registered Capture One previously, you may already have a user account with us.

Phase One Information

For various articles on Phase One products, including system and software documentation, as well as additional resources such as training and tutorials, or the user forum, please consult the online Knowledge Base at support.phaseone.com

Warranty and Uptime Guarantee

Phase One camera systems come with either a 1 Year Classic Warranty, or a 5 Year Warranty and 5 Year Uptime Guarantee. The Warranty options are available at the time of purchase.

1 Year Classic Warranty

Items covered by the 1 Year Warranty:

Phase One XF Camera Body, IQ Digital Back, XF viewfinders, Phase One and Schneider Kreuznach lenses, when purchased as stand alone items.

Phase One XF IQ1 Camera Systems including:

Phase One IQ1 digital back
Phase One XF Camera Body
XF Prism Viewfinder or XF waist level finder
Phase One or Schneider Kreuznach lenses.

To activate the Phase One warranty, customers are required to register the product online at www.phaseone.com/My-Pages, or through the registration option when the camera is tethered through Capture One Pro.

General Conditions

Subject to the terms contained here and below, Phase One warranties above mentioned products manufactured by Phase One against defects in materials and workmanship for a period of 1 year or 100,000 captures, whichever comes first from the date of purchase, covering parts and labor for repairs.

This warranty gives you specific legal rights and you may have other rights that vary from region to region. You are urged to verify whether any additional rights may or may not exist dependent upon your jurisdiction. However, Phase One shall not be liable for consequential damages or loss of data.

During the warranty period, Phase One undertakes at its discretion to repair or replace defective items at no charge to the customer, when such defects are reported to Phase One within the warranty period, and the defective part(s) are returned to Phase One no later than 30 working days after expiry of the warranty period. The customer shall cover the cost of transportation to Phase One and Phase One shall cover the transportation costs for returning the products after repair.

5 Year Warranty

Items covered by the 5 Year Warranty and 5 Year Uptime Guarantee:

Phase One XF IQ3 or XF IQ2 Camera Systems, including:

Phase One IQ3 or IQ2 digital back

Phase One XF Camera Body

XF Prism Viewfinder or XF waist level finder

An optional number of Phase One or Schneider Kreuznach lenses purchased on the same system order.

To activate the Phase One warranty, customers are required to register the product online at www.phaseone.com/My-Pages, or through the registration option when the camera is tethered through Capture One Pro.

General Conditions

Subject to the terms contained here and below, Phase One warrants the mentioned products manufactured by Phase One against defects in materials and workmanship for a period of 5 years from the date of purchase, covering parts and labor for repairs.

This warranty gives you specific legal rights and you may have other rights that vary from region to region. You are urged to verify whether any additional rights may or may not exist dependent upon your jurisdiction. However, Phase One shall not be liable for consequential damages or loss of data. During the warranty period, Phase One undertakes at its discretion to repair or replace defective items at no charge to the customer, when such defects are reported to Phase One within the warranty period, and the defective part(s) are returned to Phase One no later than 30 working days after expiry of the warranty period. The customer shall cover the cost of transportation to Phase One and Phase One shall cover the transportation costs for returning the products after repair.

The warranty is limited to the repair or replacement of the faulty part. The warranty does not cover faulty items, where the customer or a third party has attempted without authorization from Phase One to make alterations or repairs, or if the fault is caused by any other circumstances or equipment than the Products themselves or if it is determined that the cause of a failure is the result of customer action or neglect (e.g., dropping or other accident), in which case all costs will be invoiced to the customer. The warranty shall cover only such defects that are due to faulty materials or workmanship. Phase One carries no responsibility for any indirect loss, e.g. consequential loss; loss of profit; loss of data; additional costs etc. as a consequence of deficiencies in Phase One's deliveries. Phase One shall have no obligation

to make repairs or replacements required through normal wear and tear or necessitated in whole or in part by catastrophe, fault or negligence of the user, improper or unauthorized use of or attempt to repair the Products by user or others, or by causes external to the products of part thereof such as, but not limited to, power failure or unusual environmental conditions.

Procedure for Warranty Repairs

Upon experiencing a problem with a Phase One product, an authorized Phase One Dealer must be contacted by you to assist you in troubleshooting the problem and if necessary in obtaining a Return Merchandise Authorization (RMA) number from Phase One. Upon receipt by Phase One, Phase One reserves the right to determine and will determine whether the problem lies within the warranty. When you deliver the product to the Dealer, you must bring the original purchase information and serial numbers, including a copy of the sales invoice. The product must be shipped for the attention of the RMA number. Shipping costs to Phase One for RMA warranty repair are borne by you, and any damages in shipping will be billed to you. We recommend that you obtain insurance to cover potential damages during transportation. RMA numbers are only valid for four (4) business days from the date of issuance so you must ship within that period. If a product is returned to Phase One (a) without an RMA number from Phase One; or (b) beyond the four (4) business day period; or (c) without proper packaging, Phase One retains the right to refuse delivery of such return and thereby to void the warranty. Thus, we suggest that you exercise great care in this process. If the product is within warranty, shipping costs in connection with the shipping of the repaired product to you will be borne by Phase One. Otherwise shipping costs are borne by you. If you are having image quality problems, you should always enclose image samples so that

Phase One can determine the reason underlying the problem you believe you are having. All repairs completed within warranty are covered by a normal 90-day guarantee or the balance of the original or extended warranty, whichever is longer. Repairs completed outside warranty are covered by six (6) months warranty on the repaired part.

5 Year Uptime Guarantee – General Conditions

Using the Uptime Guarantee you may request a component loan unit be sent to you within 24 hours*. We will ship the loan unit to you using next business day morning service at our expense.

Phase One allows you one (1) business day to verify the operation of the loan unit and return the defective product to Phase One. If the defective product is not returned within one (1) business day, a penalty fee of USD250 / EUR200 per day for using the loan unit will be invoiced.

Under the Digital Lifetime Warranty and Uptime Guarantee, a Digital Back loan unit will be available as long as the repair lasts. After the repaired product is returned to you, the loaned product must be returned to Phase One. Instructions for shipping the loaned product will be included with your repaired product. Shipping and insurance costs in connection with the shipping of the repaired product to you will be borne by Phase One. Return shipping costs of the loaned product are borne by you and must be made within 48 hours after delivery of the repaired product. Failure to return the loaned product in a timely manner will result in Phase One invoicing for the loaned product in accordance with our current list price.

*Uptime Guarantee might be impractical to achieve due to heavily enforced tax regulations, in some countries. Phase One will not be liable for carrying out the Uptime Guarantee shipments to countries where such taxation is enforced. Please ask your Phase One representatives if you are in doubt.

Coverage of Warranty

This Warranty is the complete and exclusive statement of warranty coverage, and it supersedes all prior oral, written, express or implied proposals and communications pertaining to the subject matter hereof. ALL EXPRESSED OR IMPLIED WARRANTIES FOR PHASE ONE PRODUCTS INCLUDING THE IMPLIED WARRANTIES OF MERCHANTABILITY AND FITNESS FOR A PARTICULAR PURPOSE ARE HEREBY WAIVED subject solely to the limited warranties indicated in this document. No warranties, expressed or implied, will apply after the warranty period has lapsed.

Notices

©2017 Phase One A/S. All rights reserved. Made in Denmark.

User guide version: 1.95

Feature descriptions in this manual are referring to:
XF Camera System Feature Update 4 SR1 and Capture One 11
Colorspace images created in CROMIX ColorThink.
Photos by: Søren Jonesen (Photo+Co) and Carsten Esbensen
(Erik Bjørn & Kompagni)
Insert images by Alexander Flemming and Alexia Sinclair.

On Liability

The information in this manual is provided "as is".
Under no circumstances, including negligence, shall Phase One be liable for any incidental, special, direct, indirect or consequential damages arising out of or relating to use of the information provided in this guide with or without the software and/or hardware described in the guide.
Phase One reserves the right to change this documents information at any time without prior notice.
All agreements, oral or written, based upon information within this document will be null and void by the replacement or update of this document.

Trademarks and Acknowledgements

Capture One and Phase One are either registered trademarks or trademarks of Phase One A/S in the European Union and/or other countries.
All other trademarks are the property of their respective owners.
This product includes DNG technology under license by Adobe Systems Incorporated.

The Phase One IQ Digital Back firmware includes:

Libjpeg:
=====
This software is based in part on the work of the Independent JPEG Group.
zlib:
=====

Interface of the 'zlib' general purpose compression library
Copyright (C) 1995-2012 Jean-loup Gailly and Mark Adler
This software is provided 'as-is', without any express or implied warranty. In no event will the authors be held liable for any damages arising from the use of this software.

Permission is granted to anyone to use this software for any purpose, including commercial applications, and to alter it and redistribute it freely, subject to the following restrictions:

1. The origin of this software must not be misrepresented; you must not claim that you wrote the original software. If you use this software in a product, an acknowledgment in the product documentation would be appreciated but is not required.
2. Altered source versions must be plainly marked as such, and must not be misrepresented as being the original software.
3. This notice may not be removed or altered from any source distribution.

Jean-loup Gailly Mark Adler
jloup@gzip.org madler@alumni.caltech.edu177

FCC Regulations:

§ 15.19 (a)(3)

This device complies with part 15 of the FCC Rules. Operation is subject to the following two conditions: (1) This device may not cause harmful interference, and (2) this device must accept any interference received, including interference that may cause undesired operation.

§ 15.21

Changes or modifications not expressly approved by the party responsible for compliance could void the user's authority to operate the equipment.

§ 15.105 (b)

This equipment has been tested and found to comply with the limits for a Class B digital device, pursuant to part 15 of the FCC Rules. These limits are designed to provide reasonable protection against harmful interference in a residential installation. This equipment generates, uses and can radiate radio frequency energy and, if not installed and used in accordance with the instructions, may cause harmful interference to radio communications. However, there is no guarantee that interference will not occur in a particular installation. If this equipment does cause harmful interference to radio or television reception, which can be determined by turning the equipment off and on, the user is encouraged to try to correct the interference by one or more of the following measures:

- Reorient or relocate the receiving antenna.
- Increase the separation between the equipment and receiver.
- Connect the equipment into an outlet on a circuit different from that to which the receiver is connected.
- Consult the dealer or an experienced radio/TV technician for help.

§ 15.407 (e)

Operation on the 5.15-5.25 GHz frequency band is restricted to indoor use only. The FCC requires indoor use for the 5.15-5.25 GHz band to reduce the potential for harmful interference to co-channel Mobile Satellite Systems.

§ 2.1093

RF Exposure Information (SAR)

This device is designed and manufactured not to exceed the emission limits for exposure to radio frequency (RF) energy set by the Federal Communications Commission of the U.S. Government. The exposure standard for wireless devices employs a unit of measurement known as the Specific Absorption Rate (SAR). The SAR limit adopted by the FCC is 1.6W/kg for an uncontrolled environment. Tests for SAR are conducted using standard operating positions accepted by the FCC with the device transmitting at its highest certified power level in all tested frequency bands. The FCC has granted an Equipment Authorization for this device with all reported SAR levels evaluated as in compliance with the FCC.

IQ3 Digital Back FCC ID RYK WUBR507N

XF Camera contains Profoto Air Module FCC ID W4G-RMI

RF exposure guidelines.

Although the SAR is determined at the highest certified power level, the actual SAR level of the device while operating can be well below the maximum value. This is because the device is designed to operate at multiple power levels so as

